

## N-Channel Enhancement Mode Field Effect Transistor

PRELIMINARY

### FEATURES

- 60V, 24A,  $R_{DS(ON)} = 24m\Omega @ V_{GS} = 10V$ .  
 $R_{DS(ON)} = 31m\Omega @ V_{GS} = 4.5V$ .
- Super high dense cell design for extremely low  $R_{DS(ON)}$ .
- High power and current handling capability.
- RoHS compliant.
- Surface mount Package.

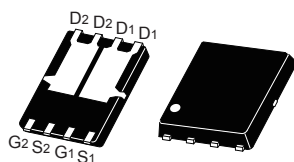

PR-PACK (5\*6)

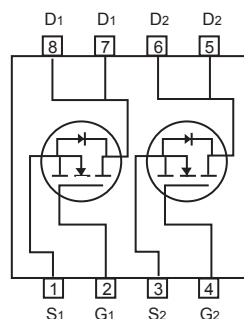

### ABSOLUTE MAXIMUM RATINGS $T_A = 25^\circ\text{C}$ unless otherwise noted

Parameter	Symbol	Limit	Units
Drain-Source Voltage	$V_{DS}$	60	V
Gate-Source Voltage	$V_{GS}$	$\pm 20$	V
Drain Current-Continuous	$I_D @ R_{\theta JA}$	8	A
	$I_D @ R_{\theta JC}$	24	A
Drain Current-Pulsed <sup>a</sup>	$I_{DM} @ R_{\theta JA}$	32	A
	$I_{DM} @ R_{\theta JC}$	96	A
Maximum Power Dissipation	$P_D$	28	W
Operating and Store Temperature Range	$T_J, T_{stg}$	-55 to 150	$^\circ\text{C}$

### Thermal Characteristics

Parameter	Symbol	Limit	Units
Thermal Resistance, Junction-to-Case	$R_{\theta JC}$	4.4	$^\circ\text{C/W}$
Thermal Resistance, Junction-to-Ambient <sup>b</sup>	$R_{\theta JA}$	40	$^\circ\text{C/W}$

## Electrical Characteristics $T_A = 25^\circ\text{C}$ unless otherwise noted

Parameter	Symbol	Test Condition	Min	Typ	Max	Units
<b>Off Characteristics</b>						
Drain-Source Breakdown Voltage	$BV_{DSS}$	$V_{GS} = 0V, I_D = 250\mu A$	60			V
Zero Gate Voltage Drain Current	$I_{DSS}$	$V_{DS} = 60V, V_{GS} = 0V$			1	$\mu A$
Gate Body Leakage Current, Forward	$I_{GSSF}$	$V_{GS} = 20V, V_{DS} = 0V$			100	nA
Gate Body Leakage Current, Reverse	$I_{GSSR}$	$V_{GS} = -20V, V_{DS} = 0V$			-100	nA
<b>On Characteristics <sup>c</sup></b>						
Gate Threshold Voltage	$V_{GS(th)}$	$V_{GS} = V_{DS}, I_D = 250\mu A$	1		3	V
Static Drain-Source On-Resistance	$R_{DS(on)}$	$V_{GS} = 10V, I_D = 6A$		20	24	$m\Omega$
		$V_{GS} = 4.5V, I_D = 4A$		24	31	$m\Omega$
<b>Dynamic Characteristics <sup>d</sup></b>						
Input Capacitance	$C_{iss}$	$V_{DS} = 25V, V_{GS} = 0V, f = 1.0\text{ MHz}$		1085		pF
Output Capacitance	$C_{oss}$			125		pF
Reverse Transfer Capacitance	$C_{rss}$			70		pF
<b>Switching Characteristics <sup>d</sup></b>						
Turn-On Delay Time	$t_{d(on)}$	$V_{DD} = 48V, I_D = 8A, V_{GS} = 10V, R_{GEN} = 10\Omega$		13		ns
Turn-On Rise Time	$t_r$			6		ns
Turn-Off Delay Time	$t_{d(off)}$			42		ns
Turn-Off Fall Time	$t_f$			6		ns
Total Gate Charge	$Q_g$	$V_{DS} = 48V, I_D = 8A, V_{GS} = 4.5V$		14		nC
Gate-Source Charge	$Q_{gs}$			2.5		nC
Gate-Drain Charge	$Q_{gd}$			7.9		nC
<b>Drain-Source Diode Characteristics and Maximum Ratings</b>						
Drain-Source Diode Forward Current <sup>b</sup>	$I_S$				23	A
Drain-Source Diode Forward Voltage <sup>c</sup>	$V_{SD}$	$V_{GS} = 0V, I_S = 1.5A$			1.2	V
<b>Notes :</b> a. Repetitive Rating : Pulse width limited by maximum junction temperature. b. Surface Mounted on FR4 Board, $t \leq 10\text{ sec}$ . c. Pulse Test : Pulse Width $\leq 300\mu s$ , Duty Cycle $\leq 2\%$ . d. Guaranteed by design, not subject to production testing.						

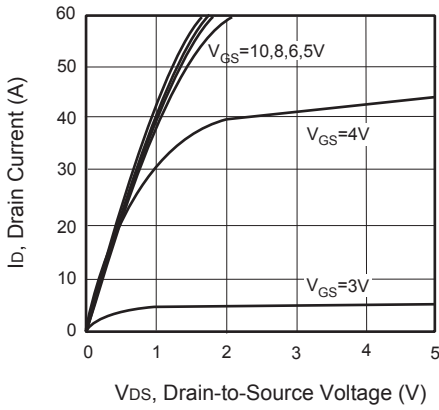

**Figure 1. Output Characteristics**

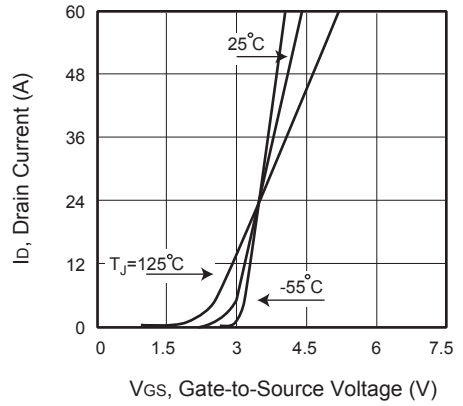

**Figure 2. Transfer Characteristics**

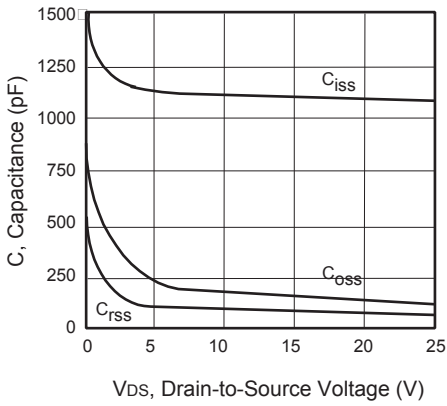

**Figure 3. Capacitance**

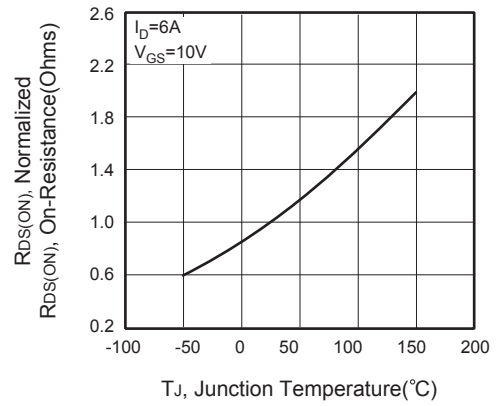

**Figure 4. On-Resistance Variation with Temperature**

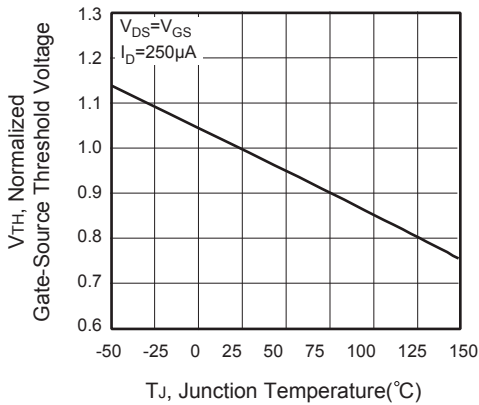

**Figure 5. Gate Threshold Variation with Temperature**

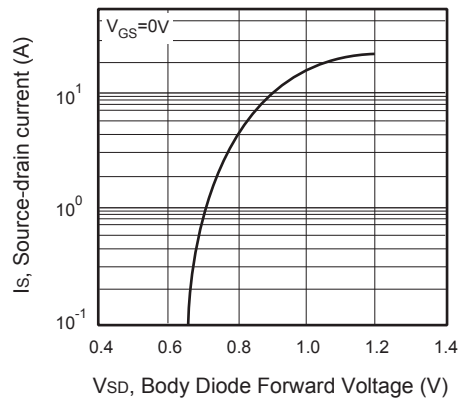

**Figure 6. Body Diode Forward Voltage Variation with Source Current**

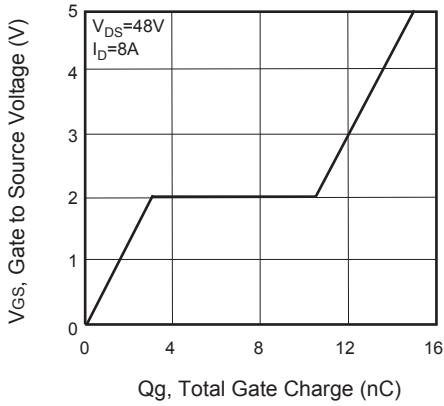

**Figure 7. Gate Charge**

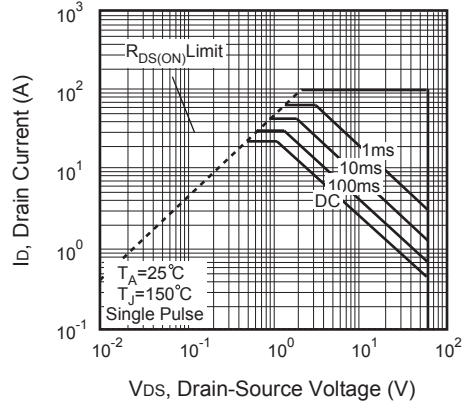

**Figure 8. Maximum Safe Operating Area**

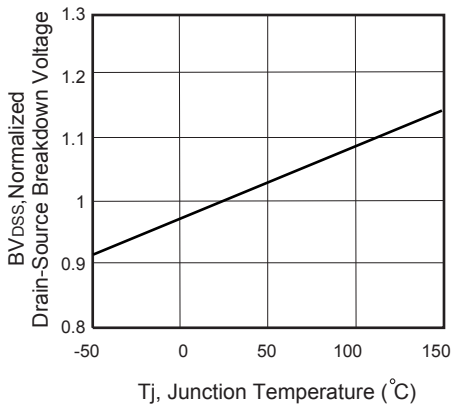

**Figure 9. Breakdown Voltage Variation VS Temperature**

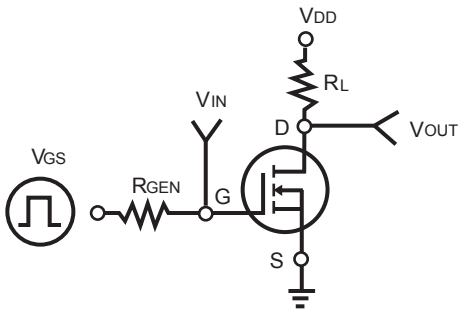

**Figure 10. Switching Test Circuit**

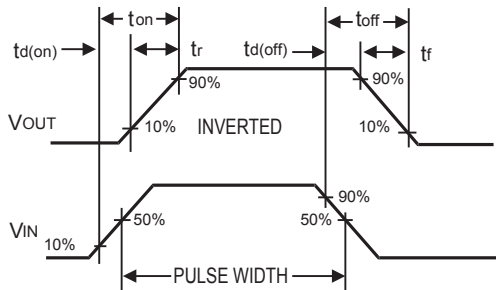

**Figure 11. Switching Waveforms**

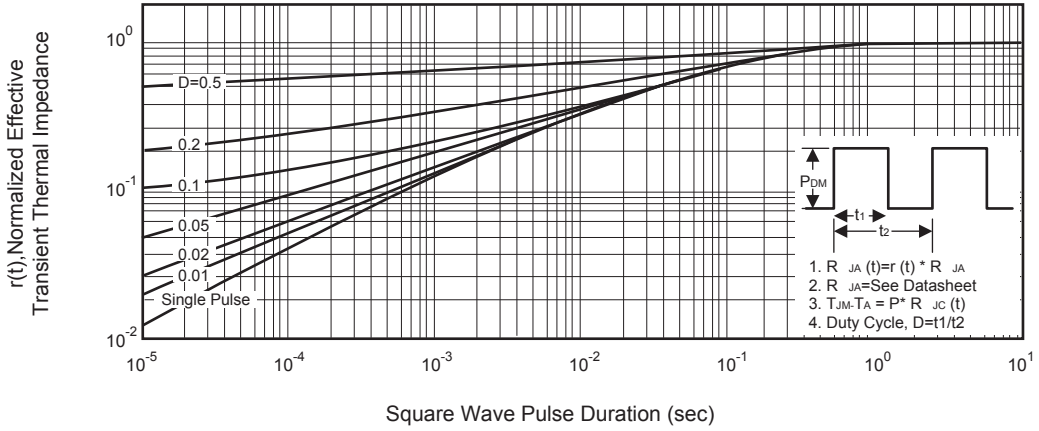

**Figure 12. Normalized Thermal Transient Impedance Curve**