



# CEP07N65LN/CEB07N65LN CEF07N65LN

## N-Channel Enhancement Mode Field Effect Transistor

### FEATURES

Type	V <sub>DSS</sub>	R <sub>DS(ON)</sub>	I <sub>D</sub>	@V <sub>GS</sub>
CEP07N65LN	650V	0.65Ω	6.5A	10V
CEB07N65LN	650V	0.65Ω	6.5A	10V
CEF07N65LN	650V	0.65Ω	6.5A <sup>d</sup>	10V

- Super high dense cell design for extremely low R<sub>DS(ON)</sub>.
- High power and current handling capability.
- RoHS compliant.

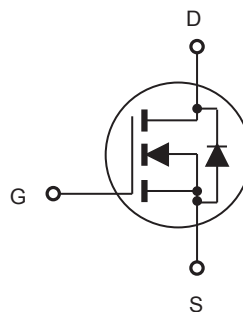
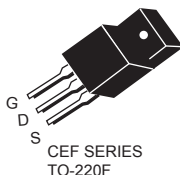
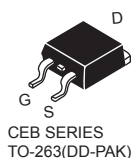

### ABSOLUTE MAXIMUM RATINGS $T_C = 25^\circ\text{C}$ unless otherwise noted

Parameter	Symbol	Limit		Units
		TO-220/263	TO-220F	
Drain-Source Voltage	V <sub>DS</sub>	650		V
Gate-Source Voltage	V <sub>GS</sub>	±30		V
Drain Current-Continuous @ T <sub>C</sub> = 25°C @ T <sub>C</sub> = 100°C	I <sub>D</sub>	6.5	6.5 <sup>d</sup>	A
		4.1	4.1 <sup>d</sup>	A
Drain Current-Pulsed <sup>a</sup>	I <sub>DM</sub> <sup>e</sup>	26	26 <sup>d</sup>	A
Maximum Power Dissipation @ T <sub>C</sub> = 25°C - Derate above 25°C	P <sub>D</sub>	69	33	W
		0.55	0.26	W/°C
Single Pulsed Avalanche Energy <sup>h</sup>	E <sub>AS</sub>	120		mJ
Single Pulsed Avalanche Current <sup>h</sup>	I <sub>AS</sub>	2		A
Operating and Store Temperature Range	T <sub>J</sub> , T <sub>stg</sub>	-55 to 150		°C

### Thermal Characteristics

Parameter	Symbol	Limit		Units
Thermal Resistance, Junction-to-Case	R <sub>θJC</sub>	1.8	3.8	°C/W
Thermal Resistance, Junction-to-Ambient	R <sub>θJA</sub>	62.5	65	°C/W



# CEP07N65LN/CEB07N65LN CEF07N65LN

## Electrical Characteristics $T_C = 25^\circ\text{C}$ unless otherwise noted

Parameter	Symbol	Test Condition	Min	Typ	Max	Units
<b>Off Characteristics</b>						
Drain-Source Breakdown Voltage	$BV_{DSS}$	$V_{GS} = 0V, I_D = 250\mu A$	650			V
Zero Gate Voltage Drain Current	$I_{DSS}$	$V_{DS} = 650V, V_{GS} = 0V$			1	$\mu A$
Gate Body Leakage Current, Forward	$I_{GSSF}$	$V_{GS} = 30V, V_{DS} = 0V$			100	nA
Gate Body Leakage Current, Reverse	$I_{GSSR}$	$V_{GS} = -30V, V_{DS} = 0V$			-100	nA
<b>On Characteristics<sup>b</sup></b>						
Gate Threshold Voltage	$V_{GS(th)}$	$V_{GS} = V_{DS}, I_D = 250\mu A$	2.5		4.5	V
Static Drain-Source On-Resistance	$R_{DS(on)}$	$V_{GS} = 10V, I_D = 3.5A$		0.55	0.65	$\Omega$
<b>Dynamic Characteristics<sup>c</sup></b>						
Input Capacitance	$C_{iss}$	$V_{DS} = 150V, V_{GS} = 0V,$ $f = 1.0\text{ MHz}$		500		pF
Output Capacitance	$C_{oss}$			65		pF
Reverse Transfer Capacitance	$C_{rss}$			20		pF
<b>Switching Characteristics<sup>c</sup></b>						
Turn-On Delay Time	$t_{d(on)}$	$V_{DD} = 300V, I_D = 3.5A,$ $V_{GS} = 15V, R_{GEN} = 10\Omega$		20		ns
Turn-On Rise Time	$t_r$			6		ns
Turn-Off Delay Time	$t_{d(off)}$			36		ns
Turn-Off Fall Time	$t_f$			3		ns
Total Gate Charge	$Q_g$	$V_{DS} = 480V, I_D = 3.5A,$ $V_{GS} = 10V$		10		nC
Gate-Source Charge	$Q_{gs}$			2.5		nC
Gate-Drain Charge	$Q_{gd}$			4.0		nC
<b>Drain-Source Diode Characteristics and Maximum Ratings</b>						
Drain-Source Diode Forward Current	$I_S^f$				6.5	A
Drain-Source Diode Forward Voltage <sup>b</sup>	$V_{SD}$	$V_{GS} = 0V, I_S = 3.5A^g$			1.5	V
<b>Notes :</b> a.Repetitive Rating : Pulse width limited by maximum junction temperature . b.Pulse Test : Pulse Width $\leq 300\mu s$ , Duty Cycle $\leq 2\%$ . c.Guaranteed by design, not subject to production testing. d.Limited only by maximum temperature allowed . e.Pulse width limited by safe operating area . f.Full package $I_{S(max)} = 4.5A$ . g.Full package $V_{SD}$ test condition $I_S = 4.5A$ . h.L = 60mH, $I_{AS} = 2A, V_{DD} = 50V, R_G = 25\Omega$ , Starting $T_J = 25\text{ C}$ .						



# CEP07N65LN/CEB07N65LN CEF07N65LN

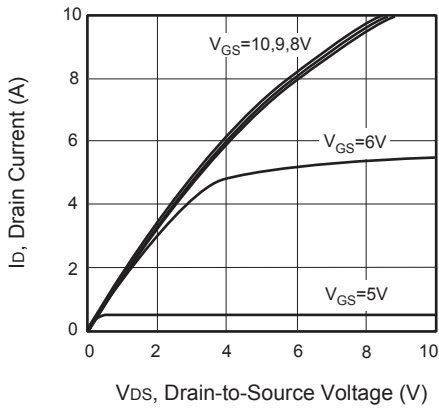

Figure 1. Output Characteristics

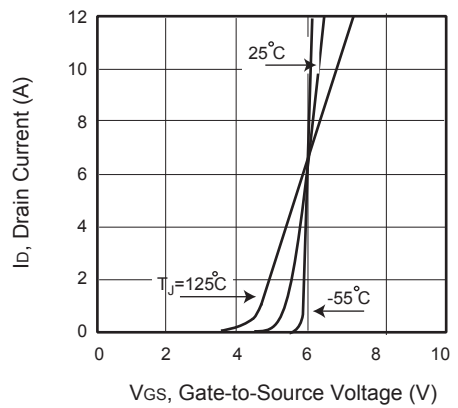

Figure 2. Transfer Characteristics

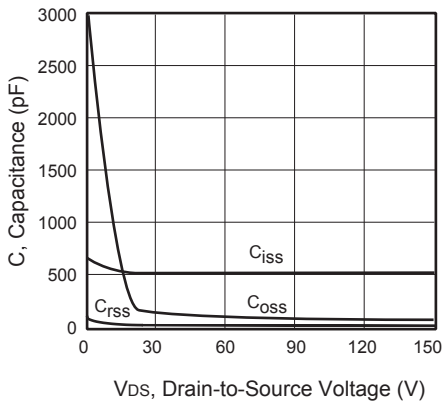

Figure 3. Capacitance

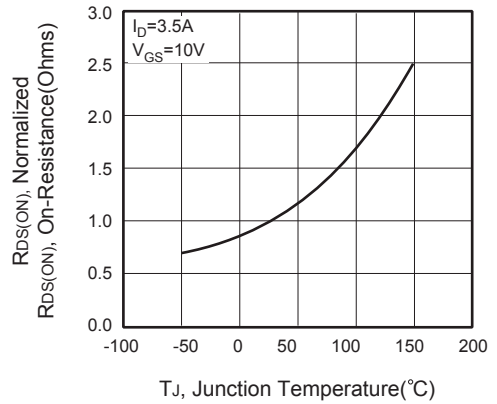

Figure 4. On-Resistance Variation with Temperature

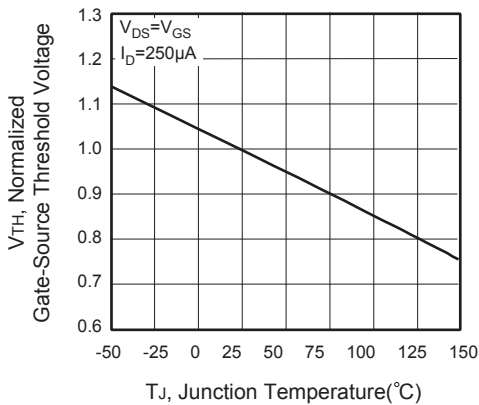

Figure 5. Gate Threshold Variation with Temperature

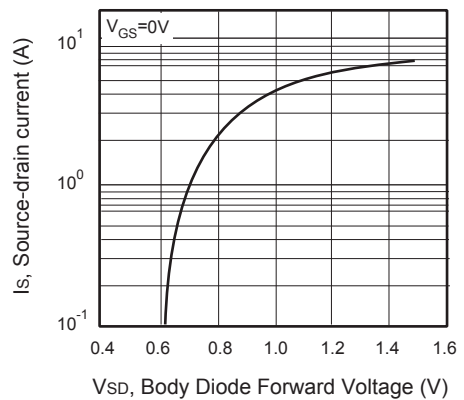

Figure 6. Body Diode Forward Voltage Variation with Source Current

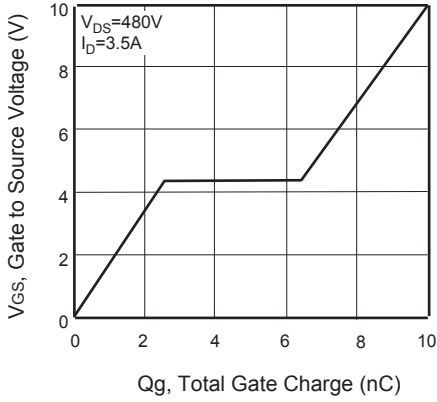

Figure 7. Gate Charge

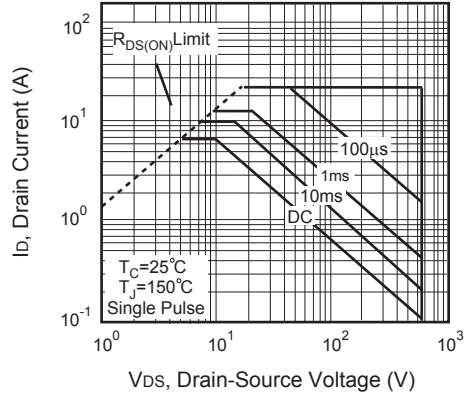

Figure 8. Maximum Safe Operating Area

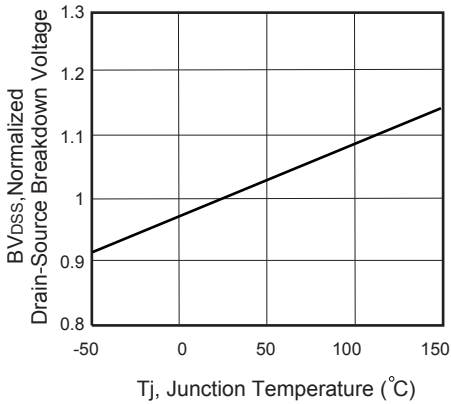

Figure 9. Breakdown Voltage Variation VS Temperature

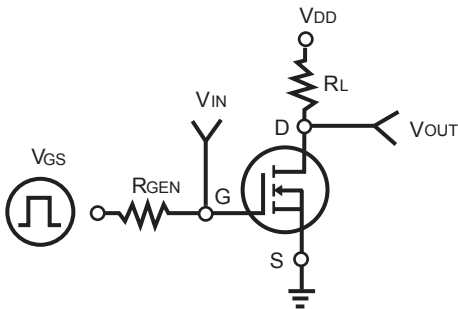

Figure 10. Switching Test Circuit

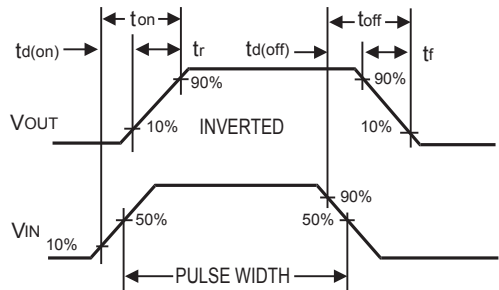

Figure 11. Switching Waveforms



# CEP07N65LN/CEB07N65LN CEF07N65LN

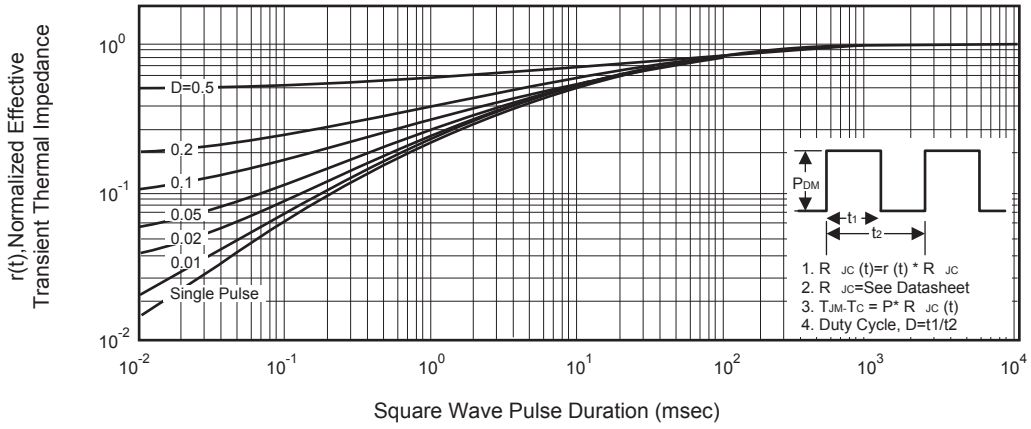

Figure 12. Normalized Thermal Transient Impedance Curve