

FEATURES

Type	V _{DSS}	R _{DS(ON)}	I _D	@V _{GS}
CEP12N65S	650V	0.38Ω	12A	10V
CEB12N65S	650V	0.38Ω	12A	10V
CEF12N65S	650V	0.38Ω	12A ^d	10V

- Super high dense cell design for extremely low R_{DS(ON)}.
- High power and current handling capability.
- RoHS compliant.

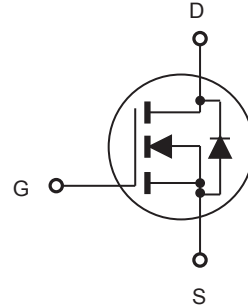
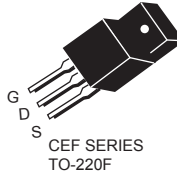

ABSOLUTE MAXIMUM RATINGS $T_C = 25^\circ\text{C}$ unless otherwise noted

Parameter	Symbol	Limit		Units
		TO-220/263	TO-220F	
Drain-Source Voltage	V _{DS}	650		V
Gate-Source Voltage	V _{GS}	±20		V
Drain Current-Continuous @ T _C = 25°C @ T _C = 100°C	I _D	12	12 ^d	A
		8	8 ^d	A
Drain Current-Pulsed ^a	I _{DM} ^e	48	48 ^d	A
Maximum Power Dissipation @ T _C = 25°C - Derate above 25°C	P _D	139	33	W
		1.1	0.26	W/°C
Single Pulsed Avalanche Energy ^h	E _{AS}	210		mJ
Single Pulsed Avalanche Current ^h	I _{AS}	1.7		A
Operating and Store Temperature Range	T _J , T _{stg}	-55 to 150		°C

Thermal Characteristics

Parameter	Symbol	Limit		Units
Thermal Resistance, Junction-to-Case	R _{θJC}	0.9	3.8	°C/W
Thermal Resistance, Junction-to-Ambient	R _{θJA}	62.5	65	°C/W



CEP12N65S/CEB12N65S CEF12N65S

Electrical Characteristics $T_C = 25^\circ\text{C}$ unless otherwise noted

Parameter	Symbol	Test Condition	Min	Typ	Max	Units
Off Characteristics						
Drain-Source Breakdown Voltage	BV_{DSS}	$V_{GS} = 0V, I_D = 250\mu A$	650			V
Zero Gate Voltage Drain Current	I_{DSS}	$V_{DS} = 650V, V_{GS} = 0V$			1	μA
Gate Body Leakage Current, Forward	I_{GSSF}	$V_{GS} = 20V, V_{DS} = 0V$			100	nA
Gate Body Leakage Current, Reverse	I_{GSSR}	$V_{GS} = -20V, V_{DS} = 0V$			-100	nA
On Characteristics^b						
Gate Threshold Voltage	$V_{GS(th)}$	$V_{GS} = V_{DS}, I_D = 250\mu A$	2		4	V
Static Drain-Source On-Resistance	$R_{DS(on)}$	$V_{GS} = 10V, I_D = 5.5A$		0.33	0.38	Ω
Dynamic Characteristics^c						
Input Capacitance	C_{iss}	$V_{DS} = 100V, V_{GS} = 0V,$ $f = 1.0\text{ MHz}$		780		pF
Output Capacitance	C_{oss}			80		pF
Reverse Transfer Capacitance	C_{rss}			15		pF
Switching Characteristics^c						
Turn-On Delay Time	$t_{d(on)}$	$V_{DD} = 400V, I_D = 4.8A,$ $V_{GS} = 10V, R_{GEN} = 3.4\Omega$		26		ns
Turn-On Rise Time	t_r			10		ns
Turn-Off Delay Time	$t_{d(off)}$			64		ns
Turn-Off Fall Time	t_f			15		ns
Total Gate Charge	Q_g	$V_{DS} = 480V, I_D = 4.8A,$ $V_{GS} = 10V$		21		nC
Gate-Source Charge	Q_{gs}			3		nC
Gate-Drain Charge	Q_{gd}			8		nC
Drain-Source Diode Characteristics and Maximum Ratings						
Drain-Source Diode Forward Current	I_S^f				12	A
Drain-Source Diode Forward Voltage ^b	V_{SD}	$V_{GS} = 0V, I_S = 5.5A^g$			1.2	V
Notes : a.Repetitive Rating : Pulse width limited by maximum junction temperature . b.Pulse Test : Pulse Width $\leq 300\mu s$, Duty Cycle $\leq 2\%$. c.Guaranteed by design, not subject to production testing. d.Limited only by maximum temperature allowed . e.Pulse width limited by safe operating area . f.Full package $I_{S(max)} = 6A$. g.Full package V_{SD} test condition $I_S = 6A$. h.L = 130mH, $I_{AS} = 1.7A, V_{DD} = 50V, R_G = 25\Omega$, Starting $T_J = 25\text{ C}$						



CEP12N65S/CEB12N65S CEF12N65S

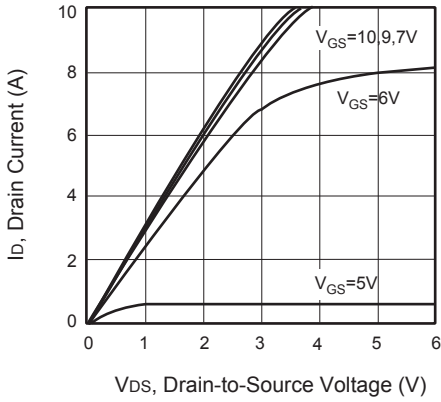

Figure 1. Output Characteristics

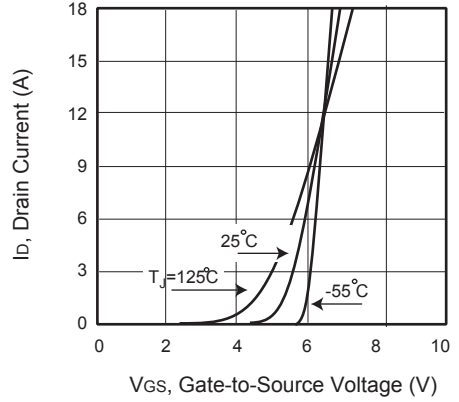

Figure 2. Transfer Characteristics

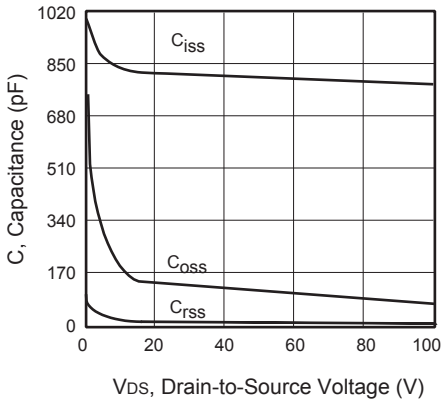

Figure 3. Capacitance

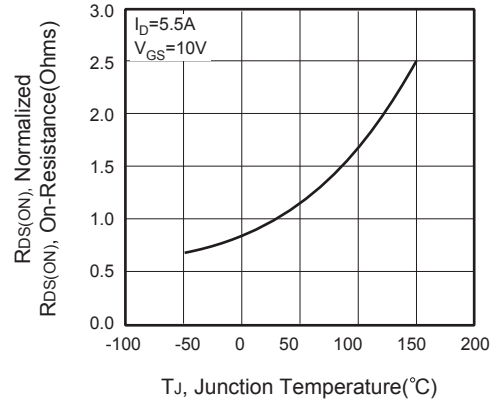

Figure 4. On-Resistance Variation with Temperature



Figure 5. Gate Threshold Variation with Temperature

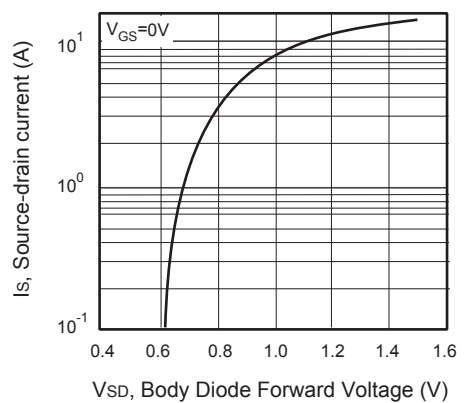

Figure 6. Body Diode Forward Voltage Variation with Source Current

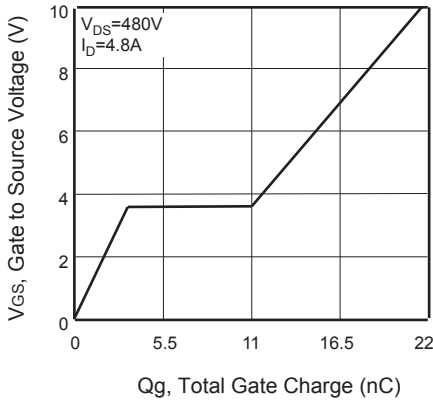

Figure 7. Gate Charge

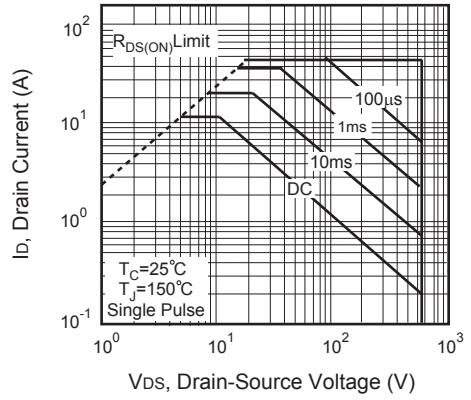

Figure 8. Maximum Safe Operating Area

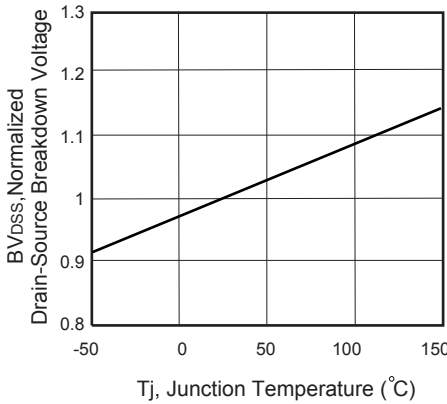

Figure 9. Breakdown Voltage Variation VS Temperature

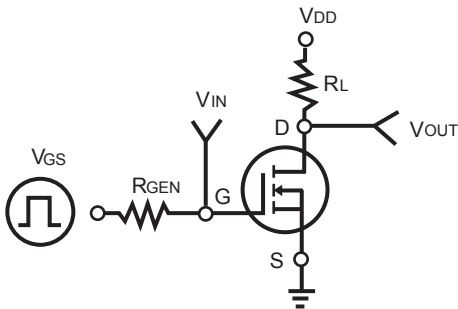

Figure 10. Switching Test Circuit

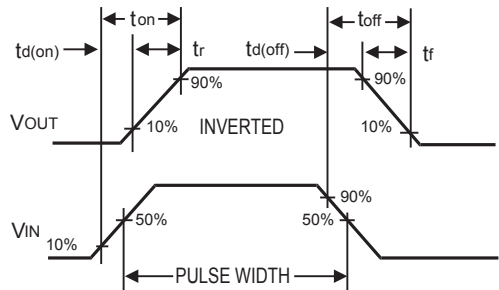

Figure 11. Switching Waveforms



CEP12N65S/CEB12N65S CEF12N65S

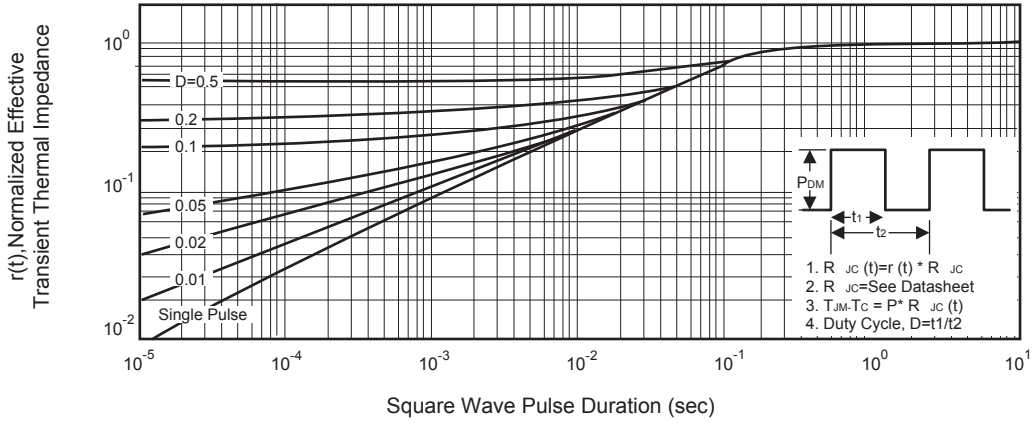

Figure 12. Normalized Thermal Transient Impedance Curve