



# CEP16N10L/CEB16N10L

## N-Channel Enhancement Mode Field Effect Transistor

PRELIMINARY

### FEATURES

- 100V, 15.2A,  $R_{DS(ON)} = 115m\Omega$  @  $V_{GS} = 10V$ .  
 $R_{DS(ON)} = 125m\Omega$  @  $V_{GS} = 5V$ .
- Super high dense cell design for extremely low  $R_{DS(ON)}$ .
- High power and current handling capability.
- Lead free product is acquired.
- TO-220 & TO-263 package.

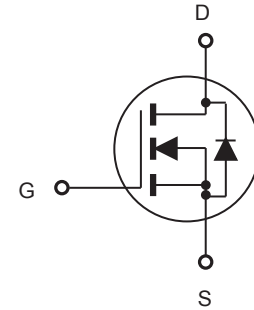

### ABSOLUTE MAXIMUM RATINGS $T_C = 25^\circ C$ unless otherwise noted

Parameter	Symbol	Limit	Units
Drain-Source Voltage	$V_{DS}$	100	V
Gate-Source Voltage	$V_{GS}$	$\pm 20$	V
Drain Current-Continuous	$I_D$	15.2	A
Drain Current-Pulsed <sup>a</sup>	$I_{DM}$	60	A
Maximum Power Dissipation @ $T_C = 25^\circ C$ - Derate above $25^\circ C$	$P_D$	60	W
		0.48	W/ $^\circ C$
Operating and Store Temperature Range	$T_J, T_{stg}$	-55 to 175	$^\circ C$

### Thermal Characteristics

Parameter	Symbol	Limit	Units
Thermal Resistance, Junction-to-Case	$R_{\theta JC}$	2.5	$^\circ C/W$
Thermal Resistance, Junction-to-Ambient	$R_{\theta JA}$	50	$^\circ C/W$



# CEP16N10L/CEB16N10L

## Electrical Characteristics $T_C = 25^\circ\text{C}$ unless otherwise noted

Parameter	Symbol	Test Condition	Min	Typ	Max	Units
<b>Off Characteristics</b>						
Drain-Source Breakdown Voltage	$BV_{DSS}$	$V_{GS} = 0V, I_D = 250\mu A$	100			V
Zero Gate Voltage Drain Current	$I_{DSS}$	$V_{DS} = 100V, V_{GS} = 0V$			1	$\mu A$
Gate Body Leakage Current, Forward	$I_{GSSF}$	$V_{GS} = 20V, V_{DS} = 0V$			100	nA
Gate Body Leakage Current, Reverse	$I_{GSSR}$	$V_{GS} = -20V, V_{DS} = 0V$			-100	nA
<b>On Characteristics<sup>b</sup></b>						
Gate Threshold Voltage	$V_{GS(th)}$	$V_{GS} = V_{DS}, I_D = 250\mu A$	1		3	V
Static Drain-Source On-Resistance	$R_{DS(on)}$	$V_{GS} = 10V, I_D = 7A$		95	115	$m\Omega$
		$V_{GS} = 5V, I_D = 5.5A$		100	125	$m\Omega$
Forward Transconductance	$g_{FS}$	$V_{DS} = 10V, I_D = 7A$		5		S
<b>Dynamic Characteristics<sup>c</sup></b>						
Input Capacitance	$C_{iss}$	$V_{DS} = 25V, V_{GS} = 0V, f = 1.0\text{ MHz}$		640		pF
Output Capacitance	$C_{oss}$			110		pF
Reverse Transfer Capacitance	$C_{rss}$			30		pF
<b>Switching Characteristics<sup>c</sup></b>						
Turn-On Delay Time	$t_{d(on)}$	$V_{DD} = 50V, I_D = 15A, V_{GS} = 10V, R_{GEN} = 25\Omega$		10	30	ns
Turn-On Rise Time	$t_r$			2.8	7	ns
Turn-Off Delay Time	$t_{d(off)}$			73	150	ns
Turn-Off Fall Time	$t_f$			7.5	15	ns
Total Gate Charge	$Q_g$	$V_{DS} = 80V, I_D = 15A, V_{GS} = 10V$		16	25	nC
Gate-Source Charge	$Q_{gs}$			2		nC
Gate-Drain Charge	$Q_{gd}$			3		nC
<b>Drain-Source Diode Characteristics and Maximum Ratings</b>						
Drain-Source Diode Forward Current	$I_S$				15.2	A
Drain-Source Diode Forward Voltage <sup>b</sup>	$V_{SD}$	$V_{GS} = 0V, I_S = 15.2A$			1.5	V
<b>Notes :</b> □ a.Repetitive Rating : Pulse width limited by maximum junction temperature b.Pulse Test : Pulse Width $\leq 300\mu s$ , Duty Cycle $\leq 2\%$ . □ c.Guaranteed by design, not subject to production testing. d. $L=0.5mH, I_{AS}=13.3A, V_{DD}=25V, R_G=25\Omega$ , Starting $T_J=25^\circ\text{C}$						

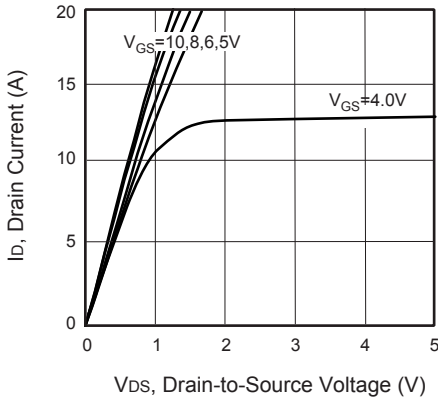

**Figure 1. Output Characteristics**

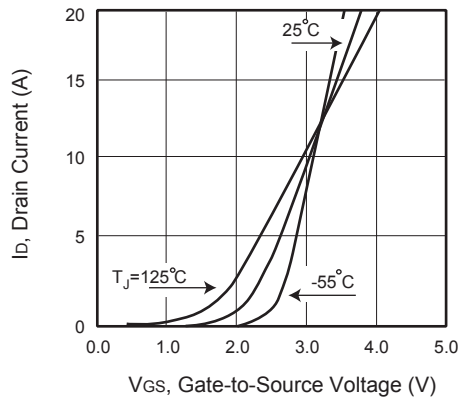

**Figure 2. Transfer Characteristics**

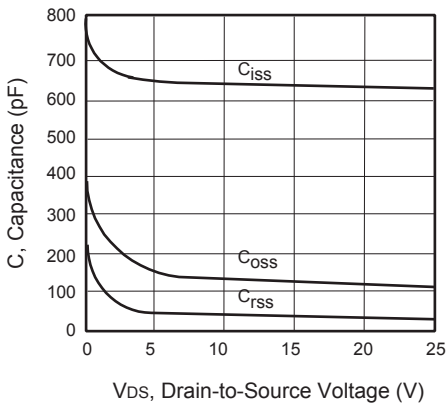

**Figure 3. Capacitance**

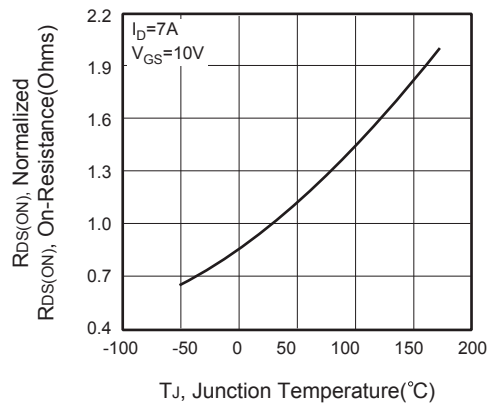

**Figure 4. On-Resistance Variation with Temperature**

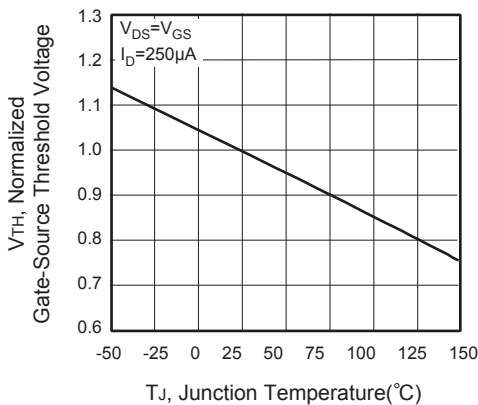

**Figure 5. Gate Threshold Variation with Temperature**

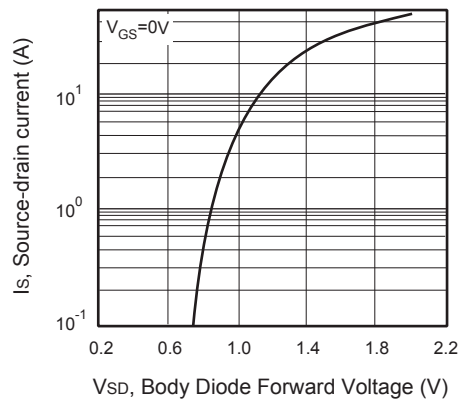

**Figure 6. Body Diode Forward Voltage Variation with Source Current**

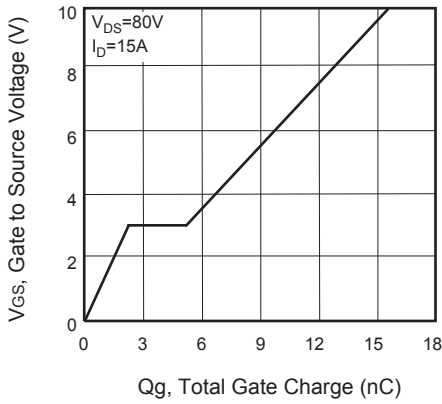

Figure 7. Gate Charge

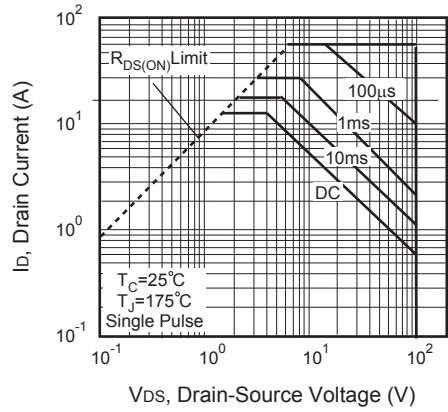

Figure 8. Maximum Safe Operating Area

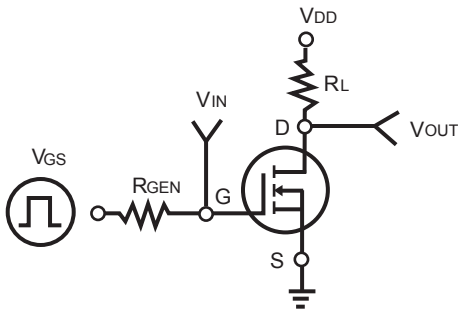

Figure 9. Switching Test Circuit



Figure 10. Switching Waveforms

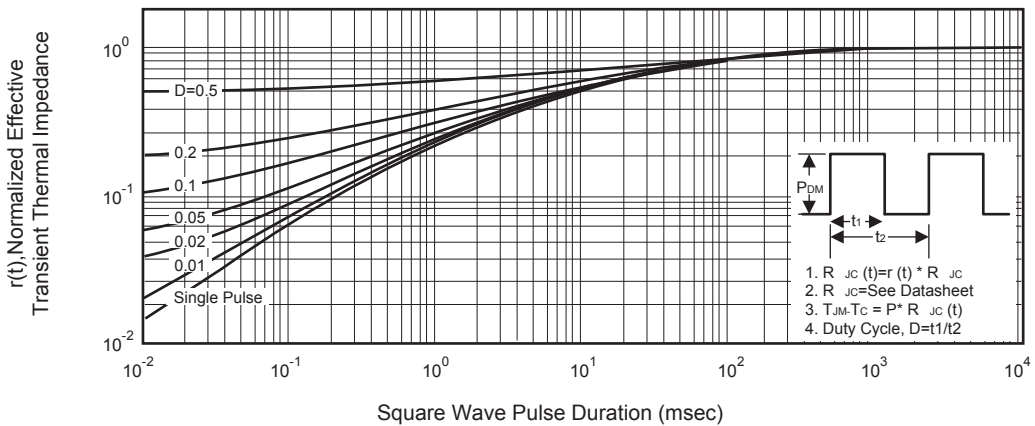

Figure 11. Normalized Thermal Transient Impedance Curve