



CEP840G/CEB840G □ CEF840G

N-Channel Enhancement Mode Field Effect Transistor

PRELIMINARY

FEATURES

Type	V _{DSS}	R _{DS(ON)}	I _D	@V _{GS}
CEP840G	500V	0.85Ω	8A	10V
CEB840G	500V	0.85Ω	8A	10V
CEF840G	500V	0.85Ω	8A ^e	10V

- Super high dense cell design for extremely low R_{DS(ON)}.
- High power and current handling capability.
- Lead free product is acquired.

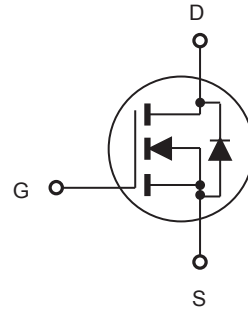
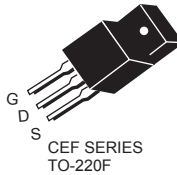

ABSOLUTE MAXIMUM RATINGS $T_C = 25^\circ\text{C}$ unless otherwise noted

Parameter	Symbol	Limit		Units
		TO-220/263	TO-220F	
Drain-Source Voltage	V _{DS}	500		V
Gate-Source Voltage	V _{GS}	±30		V
Drain Current-Continuous	I _D	8	8 ^e	A
Drain Current-Pulsed ^a	I _{DM} ^f	32	32 ^e	A
Maximum Power Dissipation @ T _C = 25°C - Derate above 25°C	P _D	125	40	W
		1.0	0.32	W/°C
Operating and Store Temperature Range	T _J , T _{stg}	-55 to 150		°C

Thermal Characteristics

Parameter	Symbol	Limit		Units
Thermal Resistance, Junction-to-Case	R _{θJC}	1.0	3.1	°C/W
Thermal Resistance, Junction-to-Ambient	R _{θJA}	62.5	65	°C/W

This is preliminary information on a new product in development now .
Details are subject to change without notice .

Rev 1. 2007.Nov.
<http://www.cet-mos.com>



CEP840G/CEB840G

CEF840G

Electrical Characteristics $T_C = 25^\circ\text{C}$ unless otherwise noted

Parameter	Symbol	Test Condition	Min	Typ	Max	Units
Off Characteristics						
Drain-Source Breakdown Voltage	BV_{DSS}	$V_{GS} = 0V, I_D = 250\mu A$	500			V
Zero Gate Voltage Drain Current	I_{DSS}	$V_{DS} = 500V, V_{GS} = 0V$			25	μA
Gate Body Leakage Current, Forward	I_{GSSF}	$V_{GS} = 30V, V_{DS} = 0V$			100	nA
Gate Body Leakage Current, Reverse	I_{GSSR}	$V_{GS} = -30V, V_{DS} = 0V$			-100	nA
On Characteristics^b						
Gate Threshold Voltage	$V_{GS(th)}$	$V_{GS} = V_{DS}, I_D = 250\mu A$	2		4	V
Static Drain-Source On-Resistance	$R_{DS(on)}$	$V_{GS} = 10V, I_D = 4.8A$		0.65	0.85	Ω
Forward Transconductance	g_{FS}	$V_{DS} = 50V, I_D = 4.8A$		7		S
Dynamic Characteristics^c						
Input Capacitance	C_{iss}	$V_{DS} = 25V, V_{GS} = 0V,$ $f = 1.0\text{ MHz}$		1240		pF
Output Capacitance	C_{oss}			145		pF
Reverse Transfer Capacitance	C_{rss}			20		pF
Switching Characteristics^c						
Turn-On Delay Time	$t_{d(on)}$	$V_{DD} = 250V, I_D = 8A,$ $V_{GS} = 10V, R_{GEN} = 9.1\Omega$		20	40	ns
Turn-On Rise Time	t_r			9	18	ns
Turn-Off Delay Time	$t_{d(off)}$			48	92	ns
Turn-Off Fall Time	t_f			8	16	ns
Total Gate Charge	Q_g	$V_{DS} = 400V, I_D = 8A,$ $V_{GS} = 10V$		33	43.8	nC
Gate-Source Charge	Q_{gs}			6.2		nC
Gate-Drain Charge	Q_{gd}			13.9		nC
Drain-Source Diode Characteristics and Maximum Ratings						
Drain-Source Diode Forward Current	I_S^f				8	A
Drain-Source Diode Forward Voltage ^b	V_{SD}	$V_{GS} = 0V, I_S = 8A$			1.5	V
Notes : □ a.Repetitive Rating : Pulse width limited by maximum junction temperature . b.Pulse Test : Pulse Width $\leq 300\mu s$, Duty Cycle $\leq 2\%$. □ c.Guaranteed by design, not subject to production testing. □ d.Limited only by maximum temperature allowed . e.Pulse width limited by safe operating area . f.Full package $I_{S(max)} = 4.6A$.						



CEP840G/CEB840G

CEF840G

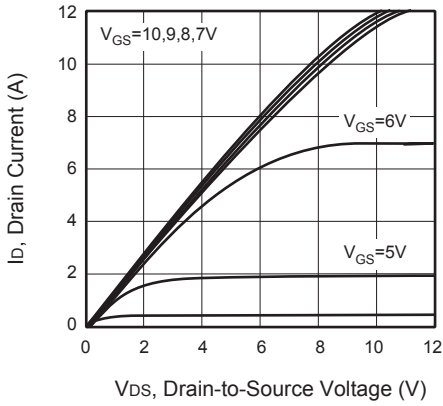

Figure 1. Output Characteristics

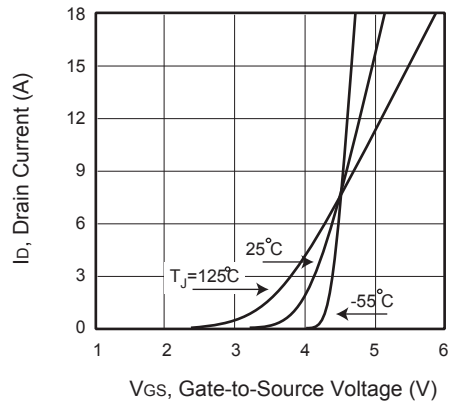

Figure 2. Transfer Characteristics

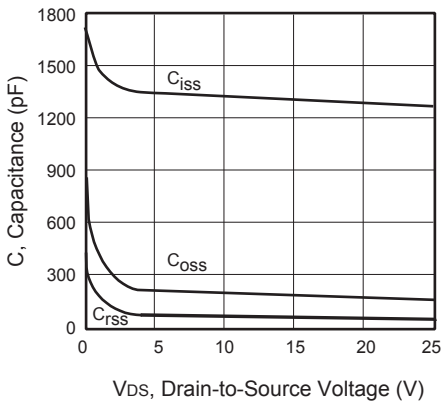

Figure 3. Capacitance

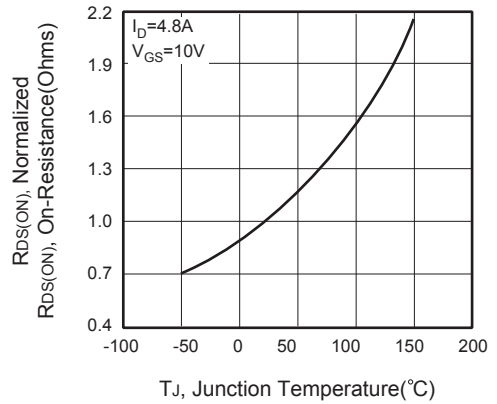

Figure 4. On-Resistance Variation with Temperature



Figure 5. Gate Threshold Variation with Temperature

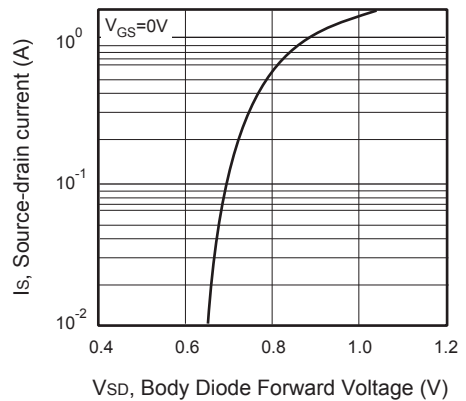

Figure 6. Body Diode Forward Voltage Variation with Source Current

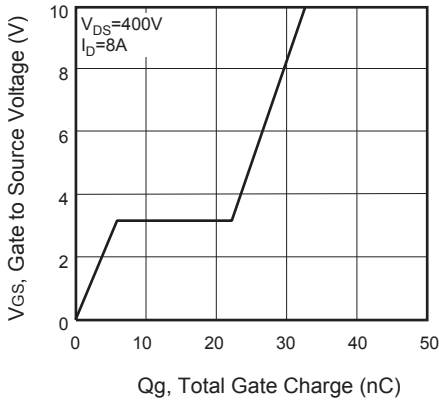

Figure 7. Gate Charge

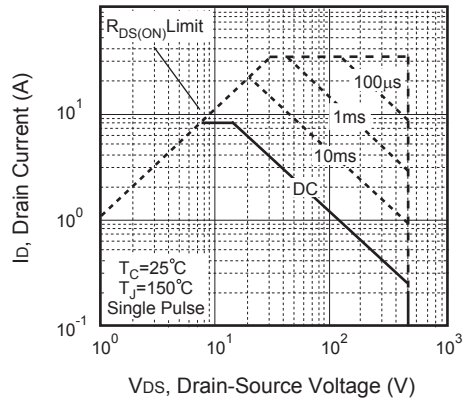

Figure 8. Maximum Safe Operating Area

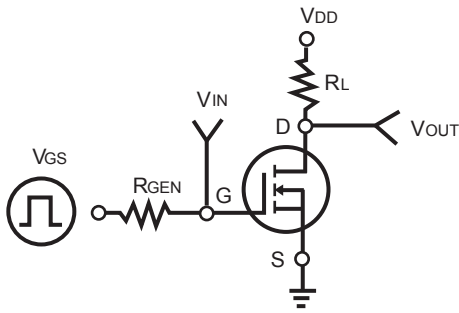

Figure 9. Switching Test Circuit



Figure 10. Switching Waveforms

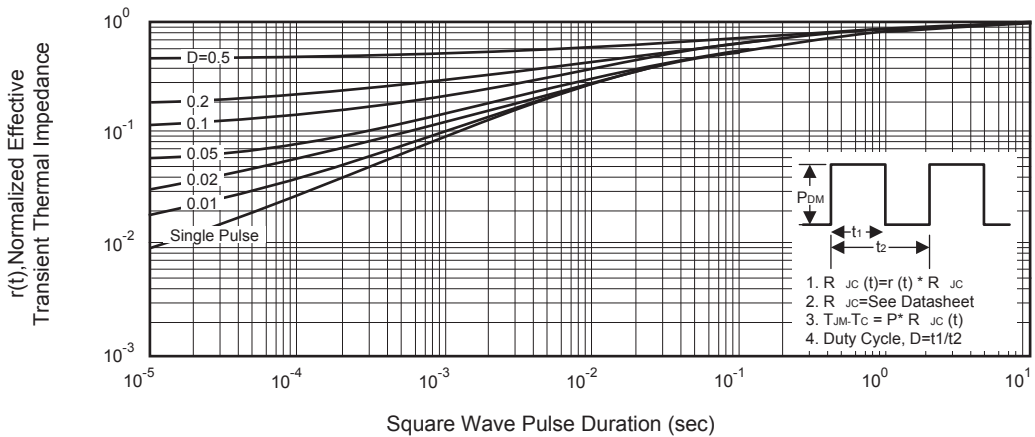

Figure 11. Normalized Thermal Transient Impedance Curve