

FEATURES

Type	V _{DSS}	R _{DS(ON)}	I _D	@V _{GS}
CEP80N15	150V	19mΩ	76A	10V
CEB80N15	150V	19mΩ	76A	10V
CEF80N15	150V	19mΩ	76A ^d	10V

- Super high dense cell design for extremely low R_{DS(ON)}.
- High power and current handling capability.
- Lead-free plating ; RoHS compliant.
- TO-220 & TO-263 & TO-220F full-pak for through hole.

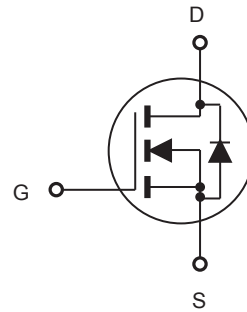

ABSOLUTE MAXIMUM RATINGS $T_C = 25^\circ\text{C}$ unless otherwise noted

Parameter	Symbol	Limit		Units
		TO-220/263	TO-220F	
Drain-Source Voltage	V _{DS}	150		V
Gate-Source Voltage	V _{GS}	±20		V
Drain Current-Continuous @ T _C = 25 C @ T _C = 100 C	I _D	76	76 ^d	A
		55	55 ^d	A
Drain Current-Pulsed ^a	I _{DM} ^e	304	304 ^d	A
Maximum Power Dissipation @ T _C = 25°C - Derate above 25°C	P _D	300	68	W
		2	0.5□	W/°C
Operating and Store Temperature Range	T _J , T _{stg}	-55 to 175		°C

Thermal Characteristics

Parameter	Symbol	Limit		Units
Thermal Resistance, Junction-to-Case	R _{θJC}	0.5	2.2	°C/W
Thermal Resistance, Junction-to-Ambient	R _{θJA}	62.5	65	°C/W



CEP80N15/CEB80N15 CEF80N15

Electrical Characteristics $T_C = 25^\circ\text{C}$ unless otherwise noted

Parameter	Symbol	Test Condition	Min	Typ	Max	Units
Off Characteristics						
Drain-Source Breakdown Voltage	BV_{DSS}	$V_{GS} = 0V, I_D = 250\mu A$	150			V
Zero Gate Voltage Drain Current	I_{DSS}	$V_{DS} = 150V, V_{GS} = 0V$			1	μA
Gate Body Leakage Current, Forward	I_{GSSF}	$V_{GS} = 20V, V_{DS} = 0V$			100	nA
Gate Body Leakage Current, Reverse	I_{GSSR}	$V_{GS} = -20V, V_{DS} = 0V$			-100	nA
On Characteristics^b						
Gate Threshold Voltage	$V_{GS(th)}$	$V_{GS} = V_{DS}, I_D = 250\mu A$	2		4	V
Static Drain-Source On-Resistance	$R_{DS(on)}$	$V_{GS} = 10V, I_D = 35A$		14	19	$m\Omega$
Dynamic Characteristics^c						
Input Capacitance	C_{iss}	$V_{DS} = 25V, V_{GS} = 0V,$ $f = 800KHz$		8540		pF
Output Capacitance	C_{oss}			455		pF
Reverse Transfer Capacitance	C_{rss}			365		pF
Switching Characteristics^c						
Turn-On Delay Time	$t_{d(on)}$	$V_{DD} = 76V, I_D = 38A,$ $V_{GS} = 10V, R_{GEN} = 5\Omega$		45	90	ns
Turn-On Rise Time	t_r			24	48	ns
Turn-Off Delay Time	$t_{d(off)}$			193	386	ns
Turn-Off Fall Time	t_f			33	66	ns
Total Gate Charge	Q_g	$V_{DS} = 76V, I_D = 38A,$ $V_{GS} = 10V$		262	340	nC
Gate-Source Charge	Q_{gs}			53		nC
Gate-Drain Charge	Q_{gd}			83		nC
Drain-Source Diode Characteristics and Maximum Ratings						
Drain-Source Diode Forward Current	I_S^f				76	A
Drain-Source Diode Forward Voltage ^b	V_{SD}	$V_{GS} = 0V, I_S = 76A^g$			1.2	V
Notes : □ a.Repetitive Rating : Pulse width limited by maximum junction temperature . b.Pulse Test : Pulse Width $\leq 300\mu s$, Duty Cycle $\leq 2\%$. □ c.Guaranteed by design, not subject to production testing. □ d.Limited only by maximum temperature allowed . e .Pulse width limited by safe operating area . f .Full package $I_{S(max)} = 37A$. g.Full package V_{SD} test condition $I_S = 37A$.						



CEP80N15/CEB80N15 CEF80N15

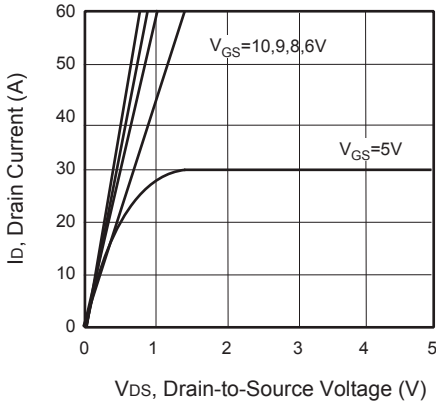

Figure 1. Output Characteristics

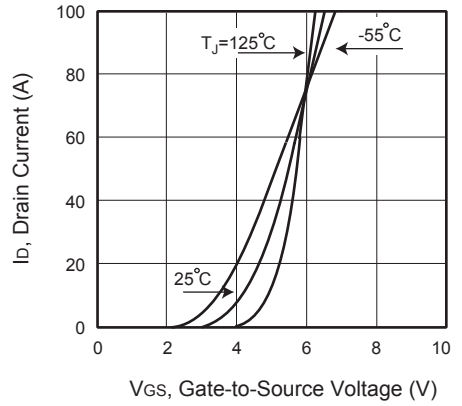

Figure 2. Transfer Characteristics

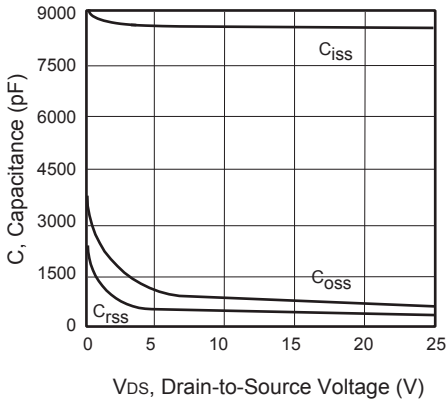

Figure 3. Capacitance

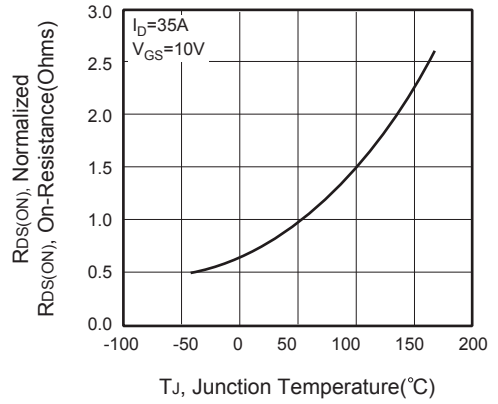

Figure 4. On-Resistance Variation with Temperature

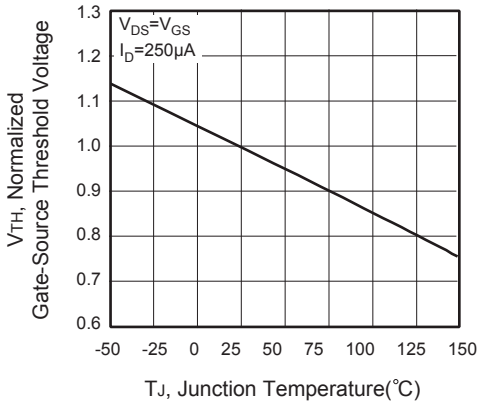

Figure 5. Gate Threshold Variation with Temperature

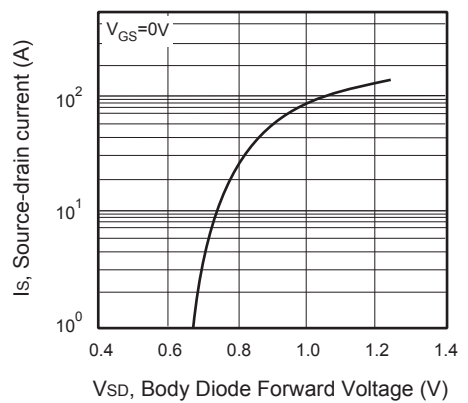

Figure 6. Body Diode Forward Voltage Variation with Source Current

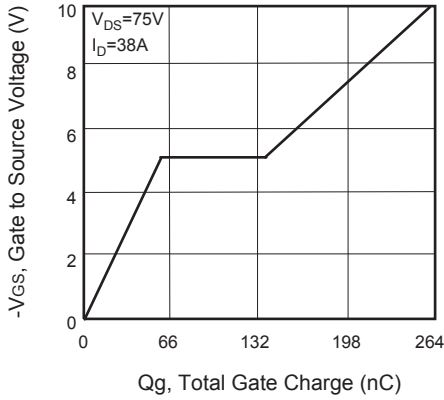

Figure 7. Gate Charge

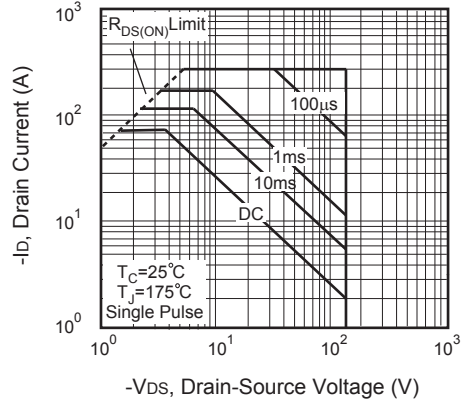

Figure 8. Maximum Safe Operating Area

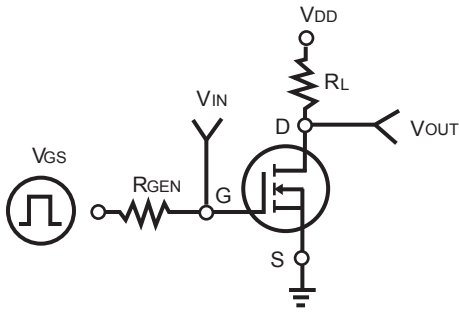

Figure 9. Switching Test Circuit

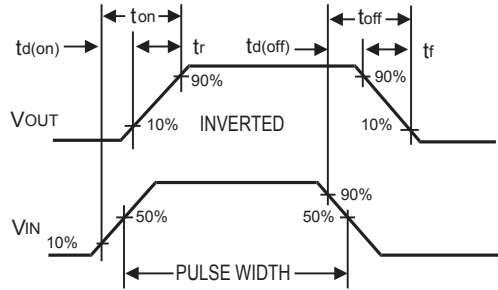

Figure 10. Switching Waveforms

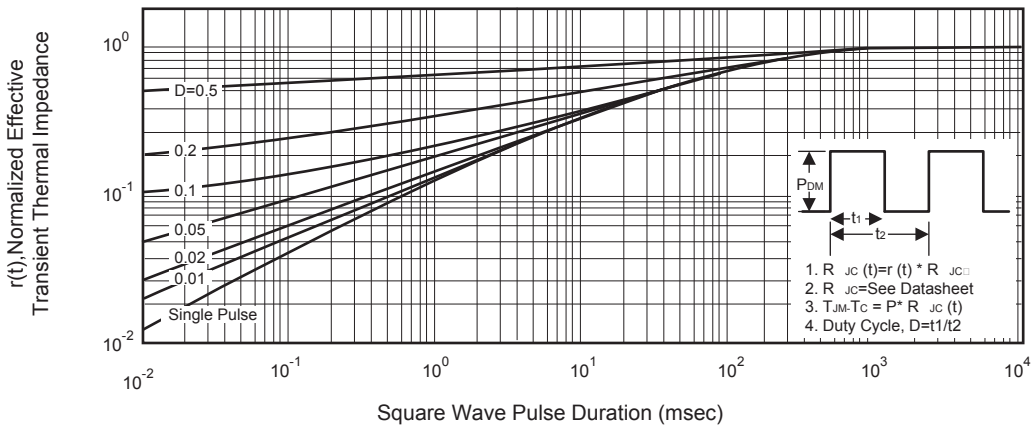

Figure 11. Normalized Thermal Transient Impedance Curve