

N-Channel Enhancement Mode Field Effect Transistor

PRELIMINARY

FEATURES

- High power and current handling capability.
- Reliable and rugged.
- Pb-free lead plating ; RoHS compliant.
- Halogen Free.

APPLICATIONS

- DC to DC Converters.
- Load Switch.
- DC FAN.
- Battery Protection.

V_{DSS}	$R_{DS(ON)}$ typ @ V_{GS}	I_D
30V	13m Ω @ $V_{GS} = 10V$	22A
30V	17m Ω @ $V_{GS} = 4.5V$	20A

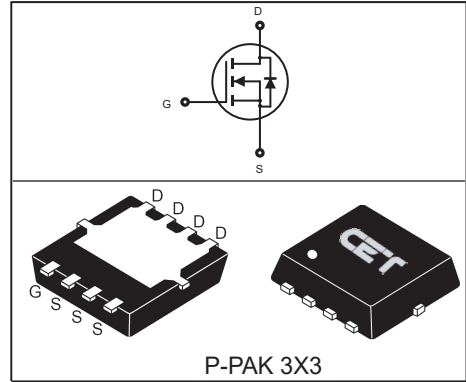

ABSOLUTE MAXIMUM RATINGS $T_C = 25^\circ\text{C}$ unless otherwise noted

Parameter		Symbol	Limit	Units
Drain-Source Voltage		V_{DS}	30	V
Gate-Source Voltage		V_{GS}	± 20	V
Drain Current-Continuous	$I_D @ R_{\theta JC}$	$T_C = 25^\circ\text{C}$	22	A
		$T_C = 100^\circ\text{C}$	14	A
	$I_D @ R_{\theta JA}$	$T_A = 25^\circ\text{C}$	8.8	A
		$T_A = 100^\circ\text{C}$	5.6	A
Drain Current-Pulsed ^a	$I_{DM} @ R_{\theta JC}$	$T_C = 25^\circ\text{C}$	88	A
	$I_{DM} @ R_{\theta JA}$	$T_A = 25^\circ\text{C}$	35.2	A
Maximum Power Dissipation		P_D	15.6	W
Operating and Store Temperature Range		T_J, T_{stg}	-55 to 150	$^\circ\text{C}$

Thermal Characteristics

Parameter	Symbol	Limit	Units
Thermal Resistance, Junction-to-Case	$R_{\theta JC}$	8	$^\circ\text{C/W}$
Thermal Resistance, Junction-to-Ambient	$R_{\theta JA}$	50	$^\circ\text{C/W}$

Electrical Characteristics $T_C = 25^\circ\text{C}$ unless otherwise noted

Parameter	Symbol	Test Condition	Min	Typ	Max	Units
Off Characteristics						
Drain-Source Breakdown Voltage	BV_{DSS}	$V_{GS} = 0V, I_D = 250\mu A$	30			V
Zero Gate Voltage Drain Current	I_{DSS}	$V_{DS} = 30V, V_{GS} = 0V$			1	μA
Gate Body Leakage Current, Forward	I_{GSSF}	$V_{GS} = 20V, V_{DS} = 0V$			100	nA
Gate Body Leakage Current, Reverse	I_{GSSR}	$V_{GS} = -20V, V_{DS} = 0V$			-100	nA
On Characteristics^b						
Gate Threshold Voltage	$V_{GS(th)}$	$V_{GS} = V_{DS}, I_D = 250\mu A$	1		3	V
Static Drain-Source On-Resistance	$R_{DS(on)}$	$V_{GS} = 10V, I_D = 8A$		13	18	$m\Omega$
		$V_{GS} = 4.5V, I_D = 6A$		17	22	$m\Omega$
Gate input resistance	R_g	$f=1\text{MHz, open Drain}$		1		Ω
Dynamic Characteristics^c						
Input Capacitance	C_{iss}	$V_{DS} = 15V, V_{GS} = 0V, f = 1.0\text{ MHz}$		460		pF
Output Capacitance	C_{oss}			80		pF
Reverse Transfer Capacitance	C_{rss}			70		pF
Switching Characteristics^c						
Turn-On Delay Time	$t_{d(on)}$	$V_{DD} = 15V, I_D = 8A, V_{GS} = 10V, R_{GEN} = 3\Omega$		14		ns
Turn-On Rise Time	t_r			10		ns
Turn-Off Delay Time	$t_{d(off)}$			27		ns
Turn-Off Fall Time	t_f			4		ns
Total Gate Charge	Q_g	$V_{DS} = 15V, I_D = 8A, V_{GS} = 4.5V$		4.6		nC
Gate-Source Charge	Q_{gs}			1.0		nC
Gate-Drain Charge	Q_{gd}			2.4		nC
Drain-Source Diode Characteristics and Maximum Ratings						
Drain-Source Diode Forward Current	I_S				14	A
Drain-Source Diode Forward Voltage ^b	V_{SD}	$V_{GS} = 0V, I_S = 1A$			1.1	V
Notes : a. Repetitive Rating : Pulse width limited by maximum junction temperature. b. Pulse Test : Pulse Width $\leq 300\mu s$, Duty Cycle $\leq 2\%$. c. Guaranteed by design, not subject to production testing.						

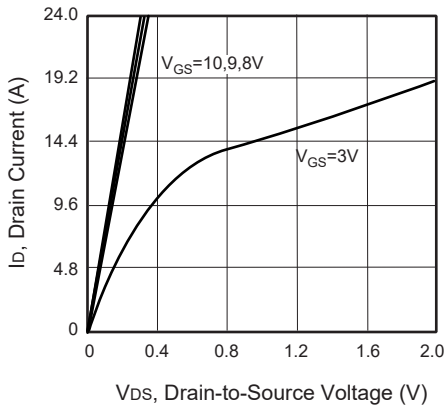

Figure 1. Output Characteristics

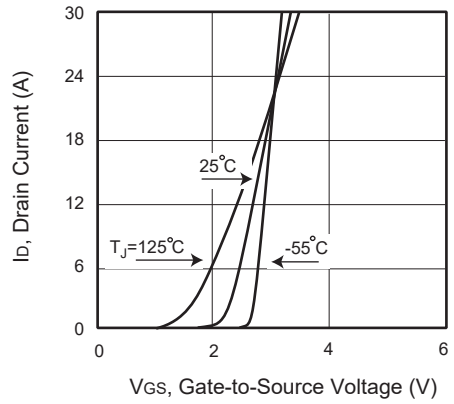

Figure 2. Transfer Characteristics

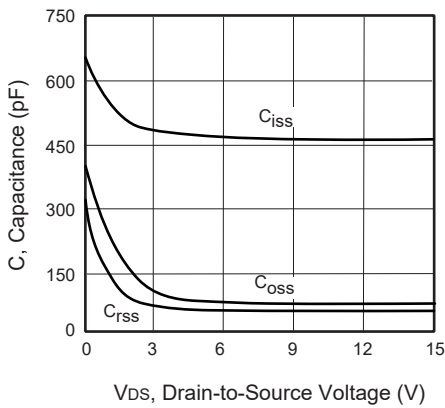

Figure 3. Capacitance

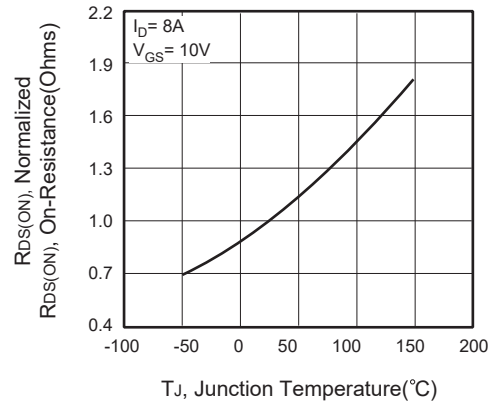

Figure 4. On-Resistance Variation with Temperature

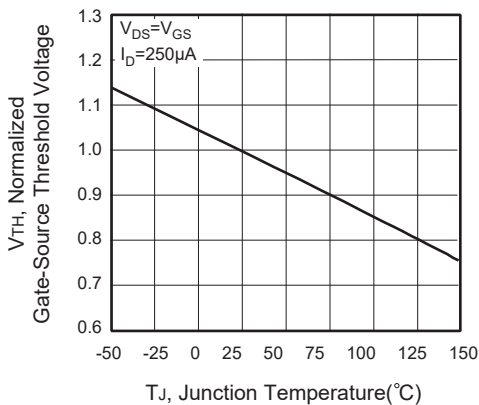

Figure 5. Gate Threshold Variation with Temperature

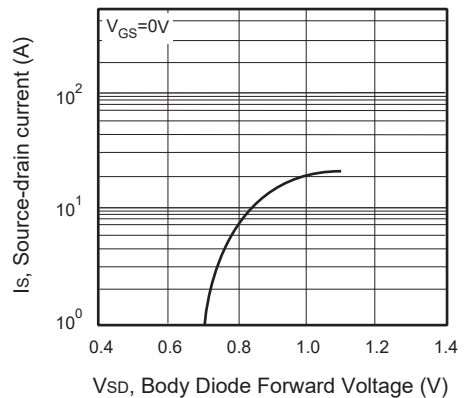

Figure 6. Body Diode Forward Voltage Variation with Source Current

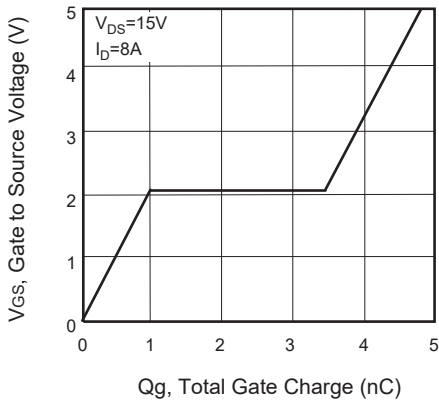

Figure 7. Gate Charge

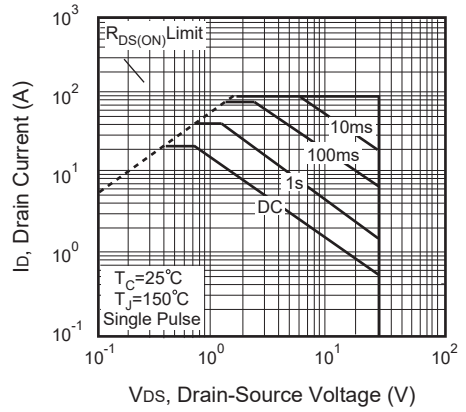

Figure 8. Maximum Safe Operating Area

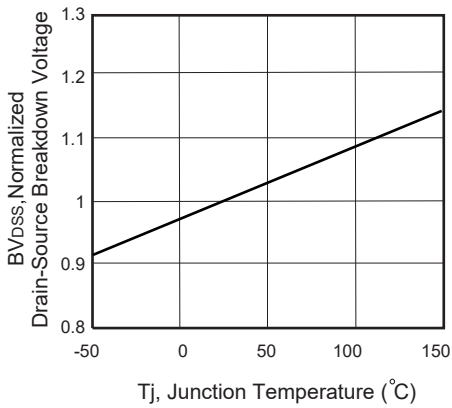

Figure 9. Breakdown Voltage Variation VS Temperature

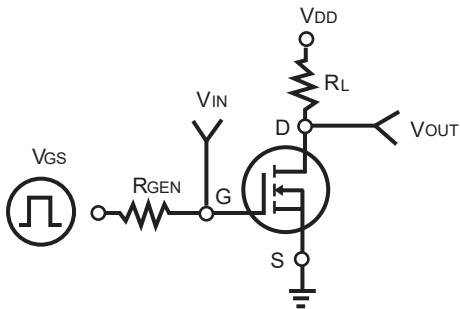

Figure 10. Switching Test Circuit

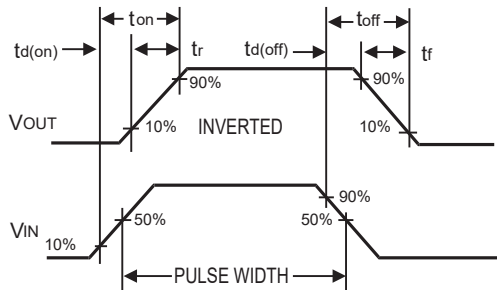

Figure 11. Switching Waveforms

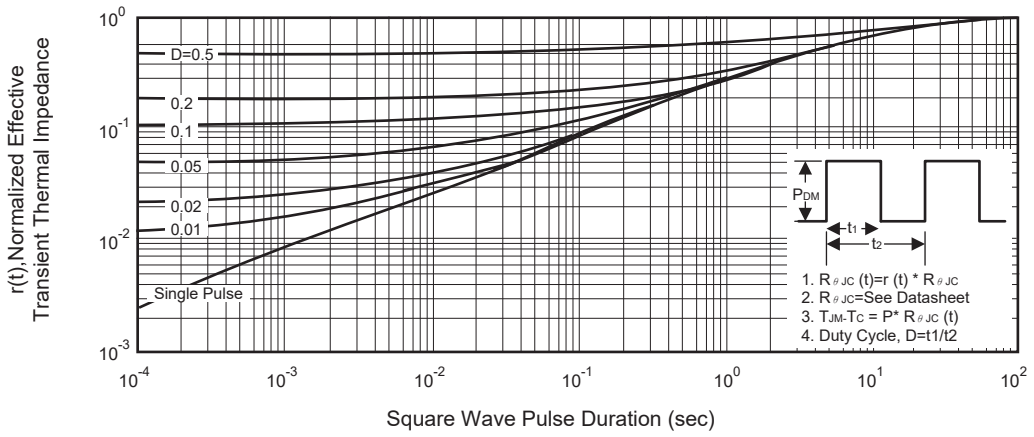
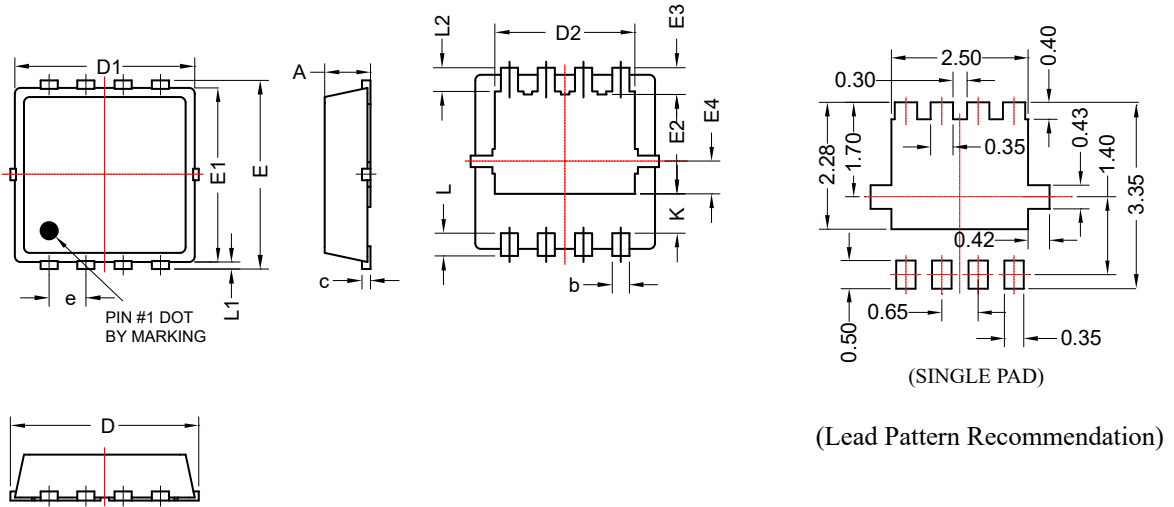

Figure 12. Normalized Thermal Transient Impedance Curve

P-PAK 3X3 產品外觀尺寸圖 (Product Outline Dimension)

SINGLE PAD 尺寸圖



SYMBOLS	MILLIMETERS		INCHES	
	MIN	MAX	MIN	MAX
A	0.7	0.85	0.028	0.033
b	0.20	0.40	0.008	0.016
c	0.10	0.25	0.004	0.010
D	3.15	3.45	0.124	0.136
D1	3.00	3.25	0.118	0.128
D2	2.29	2.65	0.090	0.104
E	3.15	3.45	0.124	0.136
E1	2.90	3.20	0.114	0.126
E2	1.54	1.94	0.061	0.076
E3	0.28	0.65	0.011	0.026
E4	0.37	0.77	0.015	0.030
e	0.65(BSC)		0.026(BSC)	
K	0.50	0.89	0.02	0.035
L	0.30	0.50	0.012	0.020
L1	0.06	0.20	0.002	0.008
L2	0.27	0.57	0.011	0.022