

## N-Channel Enhancement Mode Field Effect Transistor

### FEATURES

- 100V, 64A,  $R_{DS(ON)} = 9.6\text{ m}\Omega$  @  $V_{GS} = 10\text{V}$ .  
 $R_{DS(ON)} = 15.5\text{ m}\Omega$  @  $V_{GS} = 6\text{V}$ .
- Super high dense cell design for extremely low  $R_{DS(ON)}$ .
- High power and current handling capability.
- RoHS compliant.
- Surface mount Package.

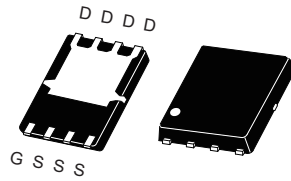

P-PAK 5X6

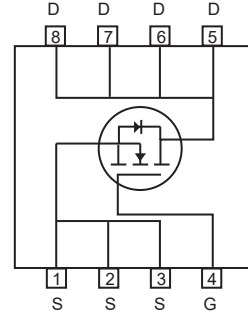

### ABSOLUTE MAXIMUM RATINGS $T_C = 25^\circ\text{C}$ unless otherwise noted

Parameter	Symbol	Limit	Units
Drain-Source Voltage	$V_{DS}$	100	V
Gate-Source Voltage	$V_{GS}$	$\pm 20$	V
Drain Current-Continuous	$I_D @ R_{\theta JC}$	64	A
Drain Current-Continuous	$I_D @ R_{\theta JA}$	19	A
Drain Current-Pulsed <sup>a</sup>	$I_{DM} @ R_{\theta JC}$	256	A
Drain Current-Pulsed <sup>a</sup>	$I_{DM} @ R_{\theta JA}$	76	A
Maximum Power Dissipation	$P_D$	71	W
Single Pulsed Avalanche Energy <sup>e</sup>	$E_{AS}$	56	mJ
Single Pulsed Avalanche Current <sup>e</sup>	$I_{AS}$	15	A
Operating and Store Temperature Range	$T_J, T_{stg}$	-55 to 150	$^\circ\text{C}$

### Thermal Characteristics

Parameter	Symbol	Limit	Units
Thermal Resistance, Junction-to-Case	$R_{\theta JC}$	1.75	$^\circ\text{C/W}$
Thermal Resistance, Junction-to-Ambient <sup>b</sup>	$R_{\theta JA}$	20	$^\circ\text{C/W}$

## Electrical Characteristics $T_C = 25^\circ\text{C}$ unless otherwise noted

Parameter	Symbol	Test Condition	Min	Typ	Max	Units
<b>Off Characteristics</b>						
Drain-Source Breakdown Voltage	$BV_{DSS}$	$V_{GS} = 0V, I_D = 250\mu A$	100			V
Zero Gate Voltage Drain Current	$I_{DSS}$	$V_{DS} = 80V, V_{GS} = 0V$			1	$\mu A$
Gate Body Leakage Current, Forward	$I_{GSSF}$	$V_{GS} = 20V, V_{DS} = 0V$			100	nA
Gate Body Leakage Current, Reverse	$I_{GSSR}$	$V_{GS} = -20V, V_{DS} = 0V$			-100	nA
<b>On Characteristics <sup>c</sup></b>						
Gate Threshold Voltage	$V_{GS(th)}$	$V_{GS} = V_{DS}, I_D = 250\mu A$	2		4	V
Static Drain-Source On-Resistance	$R_{DS(on)}$	$V_{GS} = 10V, I_D = 20A$		8	9.6	$m\Omega$
		$V_{GS} = 6V, I_D = 20A$		12	15.5	$m\Omega$
<b>Dynamic Characteristics <sup>d</sup></b>						
Input Capacitance	$C_{iss}$	$V_{DS} = 50V, V_{GS} = 0V,$ $f = 1.0\text{ MHz}$		1395		pF
Output Capacitance	$C_{oss}$			541		pF
Reverse Transfer Capacitance	$C_{rss}$			5		pF
<b>Switching Characteristics <sup>d</sup></b>						
Turn-On Delay Time	$t_{d(on)}$	$V_{DD} = 30V, I_D = 1A,$ $V_{GS} = 10V, R_{GEN} = 6\Omega$		29		ns
Turn-On Rise Time	$t_r$			7		ns
Turn-Off Delay Time	$t_{d(off)}$			48		ns
Turn-Off Fall Time	$t_f$			23		ns
Total Gate Charge	$Q_g$	$V_{DS} = 50V, I_D = 10A,$ $V_{GS} = 6V$		19		nC
Gate-Source Charge	$Q_{gs}$			6		nC
Gate-Drain Charge	$Q_{gd}$			11		nC
<b>Drain-Source Diode Characteristics and Maximum Ratings</b>						
Drain-Source Diode Forward Current	$I_S$				64	A
Drain-Source Diode Forward Voltage <sup>e</sup>	$V_{SD}$	$V_{GS} = 0V, I_S = 10A$			1.1	V
<b>Notes :</b> a. Repetitive Rating : Pulse width limited by maximum junction temperature. b. Surface Mounted on FR4 Board, $t \leq 10$ sec. c. Pulse Test : Pulse Width $\leq 300\mu s$ , Duty Cycle $\leq 2\%$ . d. Guaranteed by design, not subject to production testing. e. $L = 0.5mH, I_{AS} = 15A, V_{DD} = 50V, R_G = 25\Omega$ , Starting $T_J = 25^\circ\text{C}$ .						

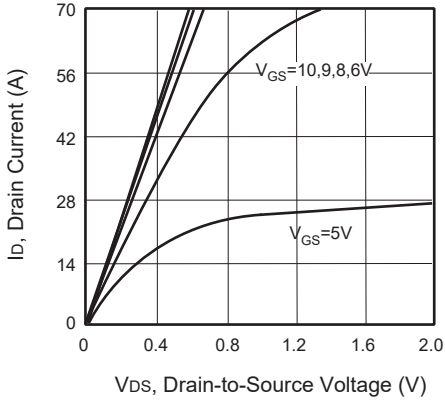

**Figure 1. Output Characteristics**

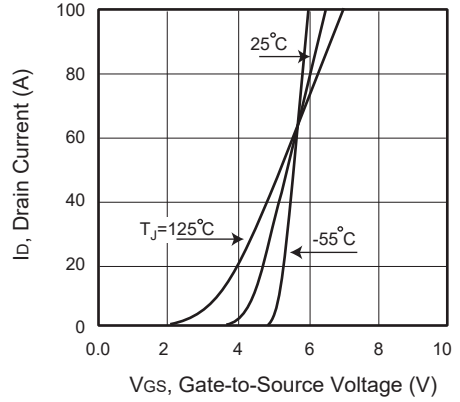

**Figure 2. Transfer Characteristics**

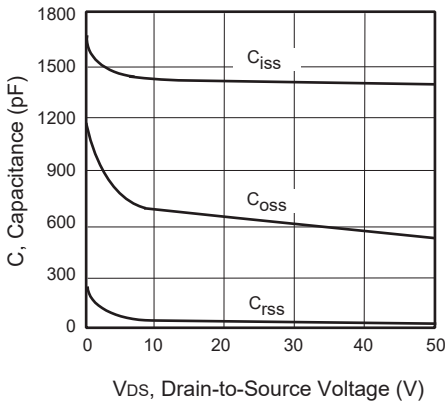

**Figure 3. Capacitance**

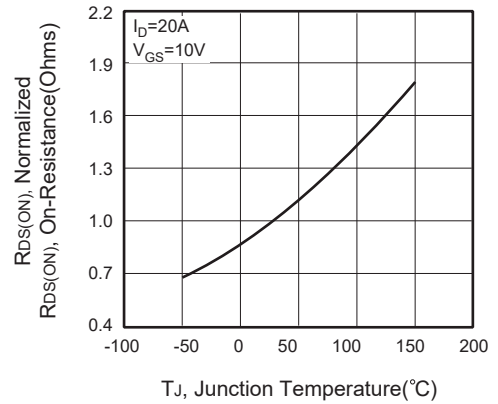

**Figure 4. On-Resistance Variation with Temperature**

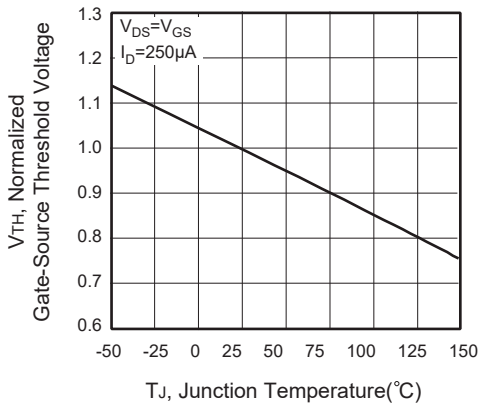

**Figure 5. Gate Threshold Variation with Temperature**

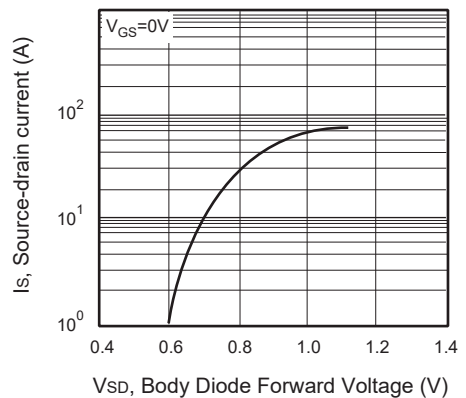

**Figure 6. Body Diode Forward Voltage Variation with Source Current**

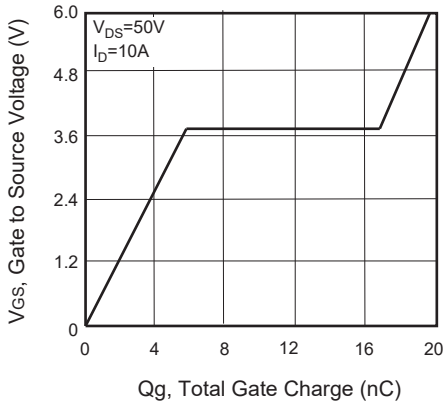

**Figure 7. Gate Charge**

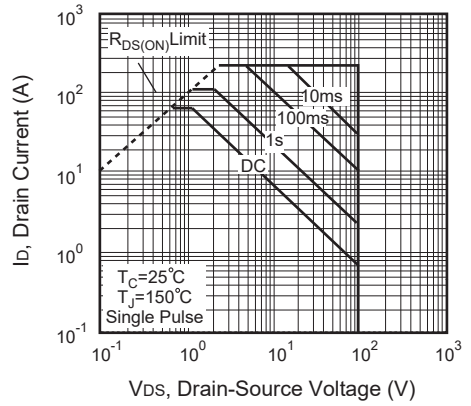

**Figure 8. Maximum Safe Operating Area**

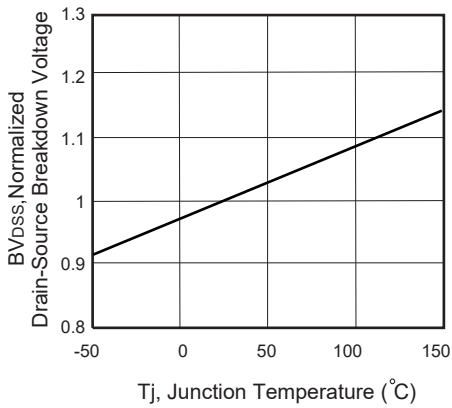

**Figure 9. Breakdown Voltage Variation VS Temperature**

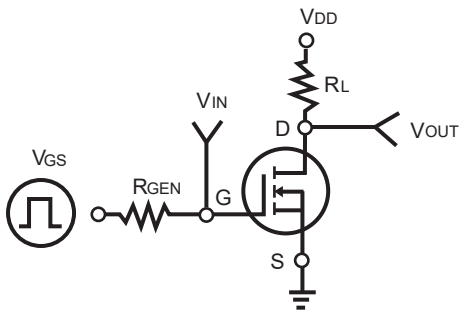

**Figure 10. Switching Test Circuit**

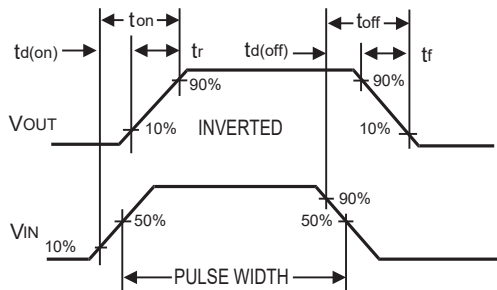

**Figure 11. Switching Waveforms**

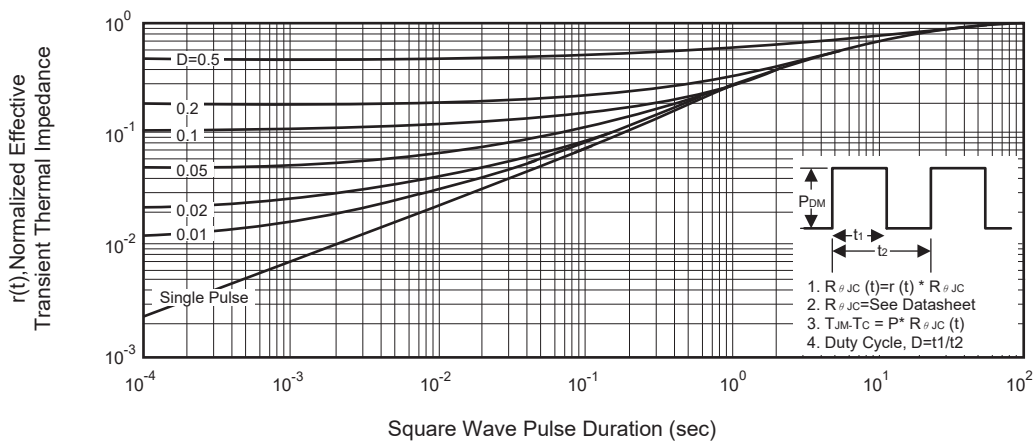

**Figure 12. Normalized Thermal Transient Impedance Curve**

## P-PAK5X6 產品外觀尺寸圖 (Product Outline Dimension)

### SINGLE PAD 尺寸圖

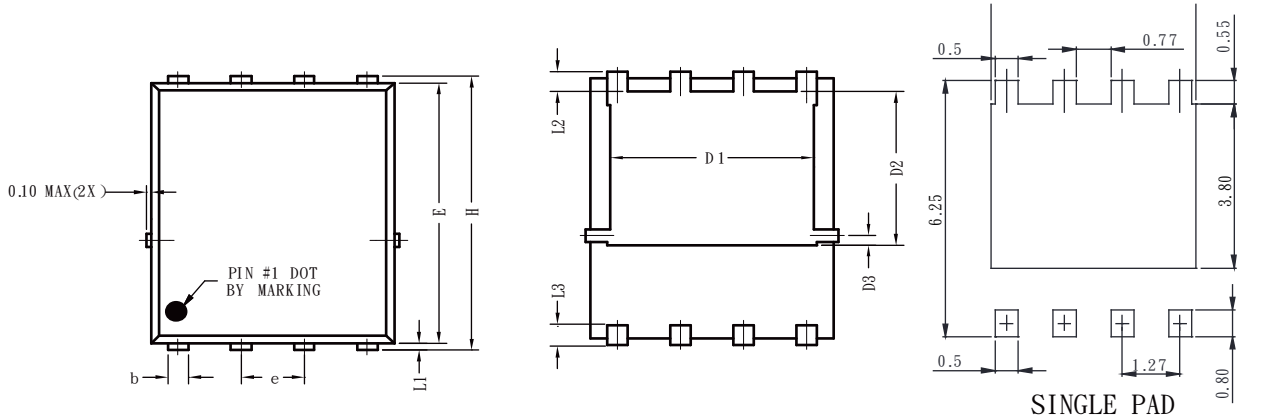

RECOMMENDED LAND PATTERN

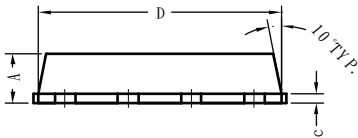

SYMBOLS	MILLIMETERS		INCHES	
	MIN	MAX	MIN	MAX
A	0.800	1.170	0.031	0.046
b	0.340	0.490	0.013	0.019
c	0.20	0.34	0.008	0.013
D	4.800	5.100	0.009	0.011
D1	3.800	4.200	0.150	0.165
D2	3.180	3.78	0.125	0.149
D3	0.150	0.360	0.006	0.142
E	5.650	5.900	0.222	0.232
e	1.270 TYP		0.050 TYP	
H	5.900	6.150	0.232	0.242
L1	0.050	0.250	0.002	0.010
L2	0.380	0.620	0.015	0.024
L3	0.380	0.75	0.015	0.030