

N-Channel Enhancement Mode Field Effect Transistor

FEATURES

- 30V, 135A, $R_{DS(ON)} = 2.3m\Omega$ @ $V_{GS} = 10V$.
 $R_{DS(ON)} = 3.8m\Omega$ @ $V_{GS} = 4.5V$.
- Super high dense cell design for extremely low $R_{DS(ON)}$.
- High power and current handling capability.
- RoHS compliant.
- Surface mount Package.

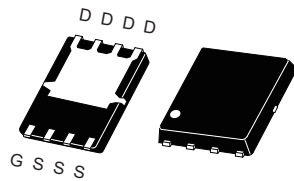

P-PAK 5X6

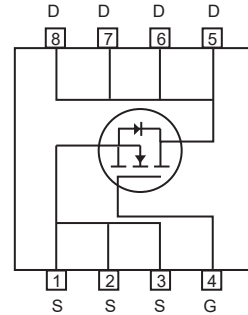

ABSOLUTE MAXIMUM RATINGS $T_A = 25^\circ C$ unless otherwise noted

Parameter	Symbol	Limit	Units
Drain-Source Voltage	V_{DS}	30	V
Gate-Source Voltage	V_{GS}	± 20	V
Drain Current-Continuous	$I_D @ R_{\theta JA}$	36	A
Drain Current-Continuous	$I_D @ R_{\theta JC}$	135	A
Drain Current-Pulsed ^a	$I_{DM} @ R_{\theta JA}$	144	A
Drain Current-Pulsed ^a	$I_{DM} @ R_{\theta JC}$	540	A
Maximum Power Dissipation	P_D	83	W
Single Pulsed Avalanche Energy ^e	E_{AS}	800	mJ
Single Pulsed Avalanche Current ^e	I_{AS}	40	A
Operating and Store Temperature Range	T_J, T_{stg}	-55 to 150	$^\circ C$

Thermal Characteristics

Parameter	Symbol	Limit	Units
Thermal Resistance, Junction-to-Case	$R_{\theta JC}$	1.5	$^\circ C/W$
Thermal Resistance, Junction-to-Ambient ^b	$R_{\theta JA}$	20	$^\circ C/W$

Electrical Characteristics $T_A = 25^\circ\text{C}$ unless otherwise noted

Parameter	Symbol	Test Condition	Min	Typ	Max	Units
Off Characteristics						
Drain-Source Breakdown Voltage	BV_{DSS}	$V_{GS} = 0V, I_D = 250\mu A$	30			V
Zero Gate Voltage Drain Current	I_{DSS}	$V_{DS} = 30V, V_{GS} = 0V$			1	μA
Gate Body Leakage Current, Forward	I_{GSSF}	$V_{GS} = 20V, V_{DS} = 0V$			100	nA
Gate Body Leakage Current, Reverse	I_{GSSR}	$V_{GS} = -20V, V_{DS} = 0V$			-100	nA
On Characteristics ^c						
Gate Threshold Voltage	$V_{GS(th)}$	$V_{GS} = V_{DS}, I_D = 250\mu A$	1		3	V
Static Drain-Source	$R_{DS(on)}$	$V_{GS} = 10V, I_D = 30A$		1.9	2.3	$m\Omega$
On-Resistance		$V_{GS} = 4.5V, I_D = 20A$		3.0	3.8	$m\Omega$
Gate input resistance	R_g	$f = 1\text{MHz, open Drain}$		2.1		Ω
Dynamic Characteristics ^d						
Input Capacitance	C_{iss}	$V_{DS} = 15V, V_{GS} = 0V, f = 1.0\text{ MHz}$		3505		pF
Output Capacitance	C_{oss}			870		pF
Reverse Transfer Capacitance	C_{rss}			595		pF
Switching Characteristics ^d						
Turn-On Delay Time	$t_{d(on)}$	$V_{DD} = 15V, I_D = 15A, V_{GS} = 10V, R_{GEN} = 1\Omega$		33		ns
Turn-On Rise Time	t_r			27		ns
Turn-Off Delay Time	$t_{d(off)}$			75		ns
Turn-Off Fall Time	t_f			36		ns
Total Gate Charge	Q_g	$V_{DS} = 15V, I_D = 15A, V_{GS} = 4.5V$		49		nC
Gate-Source Charge	Q_{gs}			12		nC
Gate-Drain Charge	Q_{gd}			28		nC
Drain-Source Diode Characteristics and Maximum Ratings						
Drain-Source Diode Forward Current ^b	I_S				80	A
Drain-Source Diode Forward Voltage ^c	V_{SD}	$V_{GS} = 0V, I_S = 20A$			1	V
Notes : □ a.Repetitive Rating : Pulse width limited by maximum junction temperature.□ b.Surface Mounted on FR4 Board, $t \leq 10\text{ sec.}$ □ c.Pulse Test : Pulse Width $\leq 300\mu s$, Duty Cycle $\leq 2\%$.□ d.Guaranteed by design, not subject to production testing.□ e.L = 1mH, $I_{AS} = 40A, V_{DD} = 24V, R_G = 25\Omega$, Starting $T_J = 25\text{ C}$						

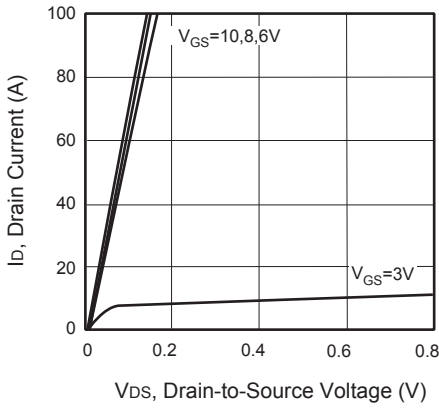

Figure 1. Output Characteristics

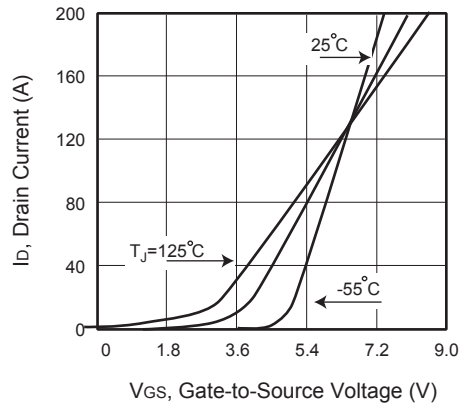

Figure 2. Transfer Characteristics

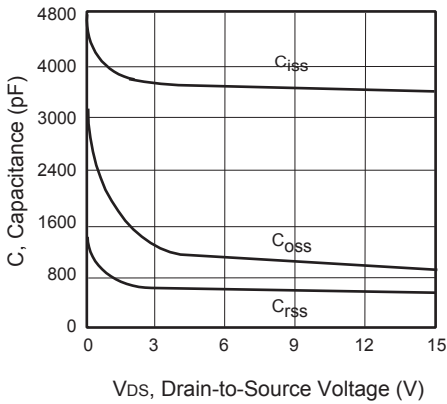

Figure 3. Capacitance

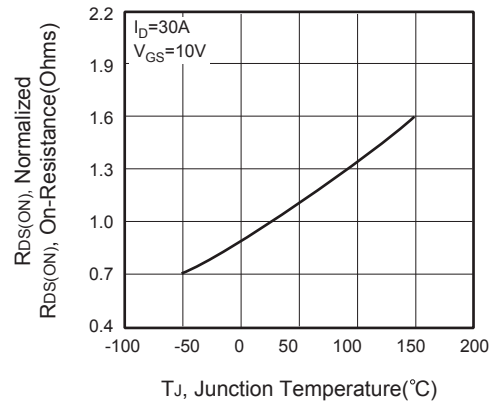

Figure 4. On-Resistance Variation with Temperature



Figure 5. Gate Threshold Variation with Temperature

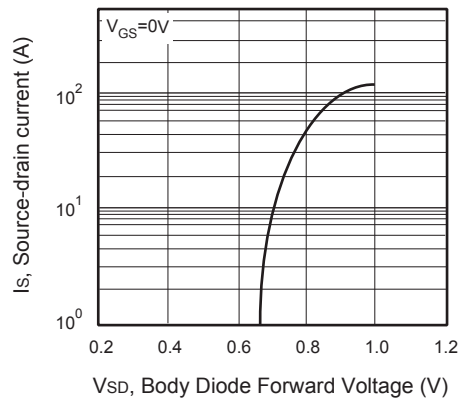

Figure 6. Body Diode Forward Voltage Variation with Source Current

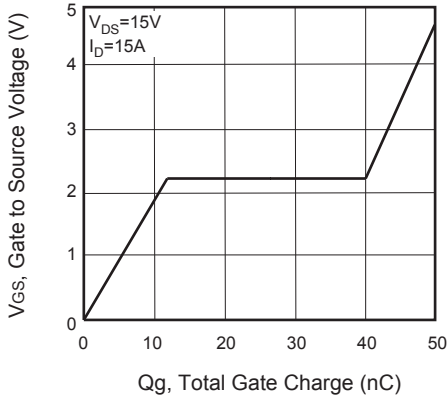

Figure 7. Gate Charge

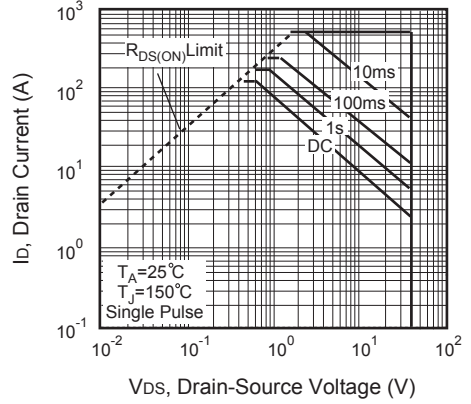

Figure 8. Maximum Safe Operating Area

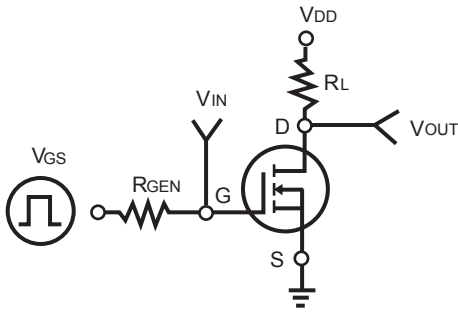

Figure 9. Switching Test Circuit

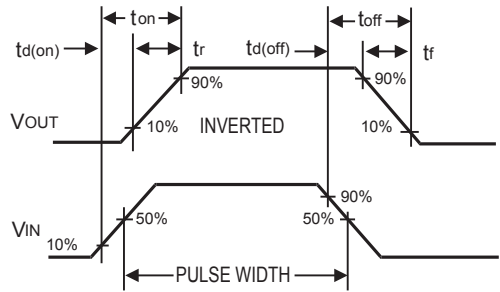

Figure 10. Switching Waveforms

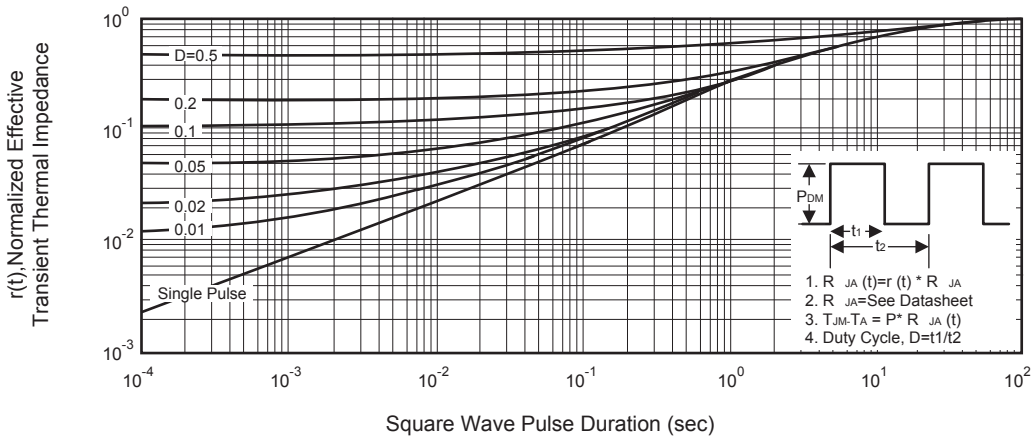

Figure 11. Normalized Thermal Transient Impedance Curve