

## N-Channel Enhancement Mode Field Effect Transistor

### FEATURES

- 30V, 86A,  $R_{DS(ON)} = 5.8m\Omega$  @ $V_{GS} = 10V$ .  
 $R_{DS(ON)} = 7.5m\Omega$  @ $V_{GS} = 4.5V$ .
- Super high dense cell design for extremely low  $R_{DS(ON)}$ .
- High power and current handling capability.
- RoHS compliant.
- Surface mount Package.

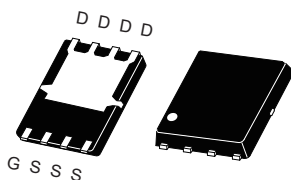

P-PAK 5X6

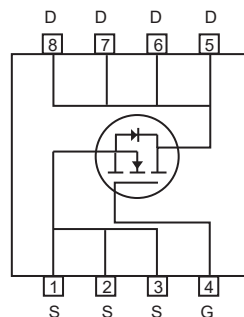

### ABSOLUTE MAXIMUM RATINGS $T_A = 25^\circ C$ unless otherwise noted

Parameter	Symbol	Limit	Units
Drain-Source Voltage	$V_{DS}$	30	V
Gate-Source Voltage	$V_{GS}$	$\pm 20$	V
Drain Current-Continuous	$I_D @ R_{\theta JA}$	26	A
Drain Current-Continuous	$I_D @ R_{\theta JC}$	86	A
Drain Current-Pulsed <sup>a</sup>	$I_{DM} @ R_{\theta JA}$	104	A
Drain Current-Pulsed <sup>a</sup>	$I_{DM} @ R_{\theta JC}$	344	A
Maximum Power Dissipation	$P_D$	83	W
Single Pulsed Avalanche Energy <sup>e</sup>	$E_{AS}$	57.8	mJ
Single Pulsed Avalanche Current <sup>e</sup>	$I_{AS}$	34	A
Operating and Store Temperature Range	$T_J, T_{stg}$	-55 to 175	$^\circ C$

### Thermal Characteristics

Parameter	Symbol	Limit	Units
Thermal Resistance, Junction-to-Case	$R_{\theta JC}$	1.8	$^\circ C/W$
Thermal Resistance, Junction-to-Ambient <sup>b</sup>	$R_{\theta JA}$	20	$^\circ C/W$

## Electrical Characteristics $T_A = 25^\circ\text{C}$ unless otherwise noted

Parameter	Symbol	Test Condition	Min	Typ	Max	Units
<b>Off Characteristics</b>						
Drain-Source Breakdown Voltage	$BV_{DSS}$	$V_{GS} = 0V, I_D = 250\mu A$	30			V
Zero Gate Voltage Drain Current	$I_{DSS}$	$V_{DS} = 30V, V_{GS} = 0V$			1	$\mu A$
Gate Body Leakage Current, Forward	$I_{GSSF}$	$V_{GS} = 20V, V_{DS} = 0V$			100	nA
Gate Body Leakage Current, Reverse	$I_{GSSR}$	$V_{GS} = -20V, V_{DS} = 0V$			-100	nA
<b>On Characteristics <sup>c</sup></b>						
Gate Threshold Voltage	$V_{GS(th)}$	$V_{GS} = V_{DS}, I_D = 250\mu A$	1		3	V
Static Drain-Source On-Resistance	$R_{DS(on)}$	$V_{GS} = 10V, I_D = 30A$		4.4	5.8	$m\Omega$
		$V_{GS} = 4.5V, I_D = 10A$		5.7	7.5	$m\Omega$
<b>Dynamic Characteristics <sup>d</sup></b>						
Input Capacitance	$C_{iss}$	$V_{DS} = 15V, V_{GS} = 0V, f = 1.0\text{ MHz}$		1395		pF
Output Capacitance	$C_{oss}$			345		pF
Reverse Transfer Capacitance	$C_{rss}$			215		pF
<b>Switching Characteristics <sup>d</sup></b>						
Turn-On Delay Time	$t_{d(on)}$	$V_{DD} = 15V, I_D = 1A, V_{GS} = 10V, R_{GEN} = 6\Omega$		14		ns
Turn-On Rise Time	$t_r$			7.2		ns
Turn-Off Delay Time	$t_{d(off)}$			55		ns
Turn-Off Fall Time	$t_f$			11		ns
Total Gate Charge	$Q_g$	$V_{DS} = 15V, I_D = 1A, V_{GS} = 5V$		20		nC
Gate-Source Charge	$Q_{gs}$			2.5		nC
Gate-Drain Charge	$Q_{gd}$			8		nC
<b>Drain-Source Diode Characteristics and Maximum Ratings</b>						
Drain-Source Diode Forward Current <sup>b</sup>	$I_S$				69	A
Drain-Source Diode Forward Voltage <sup>c</sup>	$V_{SD}$	$V_{GS} = 0V, I_S = 20A$			1.2	V
<b>Notes :</b> a.Repetitive Rating : Pulse width limited by maximum junction temperature. b.Surface Mounted on FR4 Board, $t \leq 10$ sec. c.Pulse Test : Pulse Width $\leq 300\mu s$ , Duty Cycle $\leq 2\%$ . d.Guaranteed by design, not subject to production testing. e.L = 0.1mH, $I_{AS} = 34A, V_{DD} = 24V, R_G = 25\Omega$ , Starting $T_J = 25^\circ\text{C}$ .						

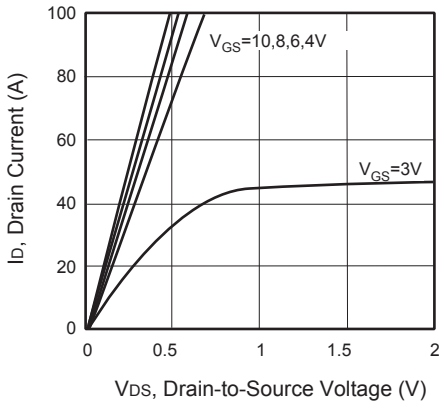

**Figure 1. Output Characteristics**

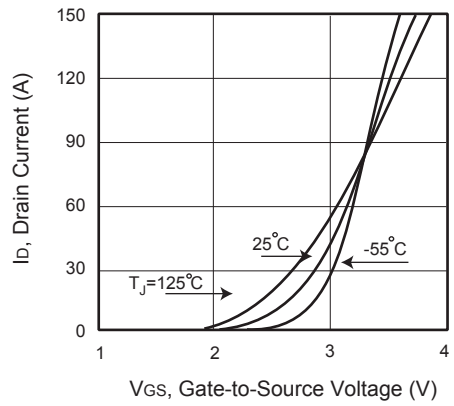

**Figure 2. Transfer Characteristics**

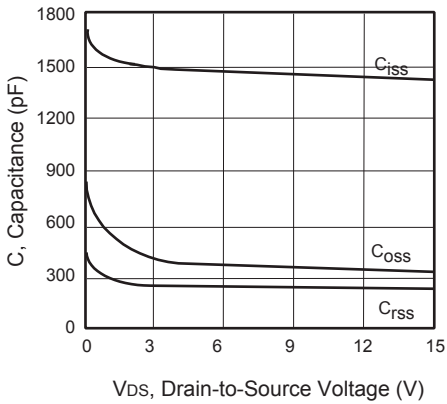

**Figure 3. Capacitance**

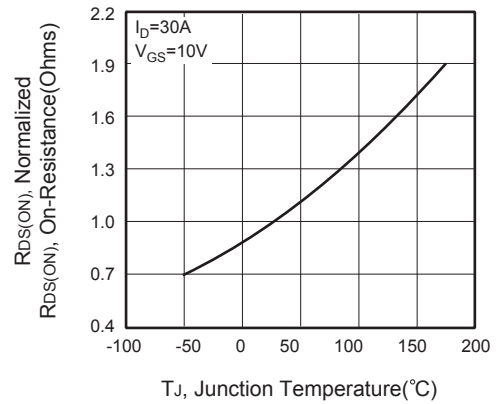

**Figure 4. On-Resistance Variation with Temperature**

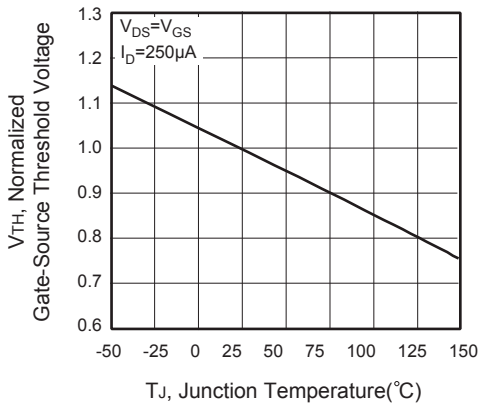

**Figure 5. Gate Threshold Variation with Temperature**

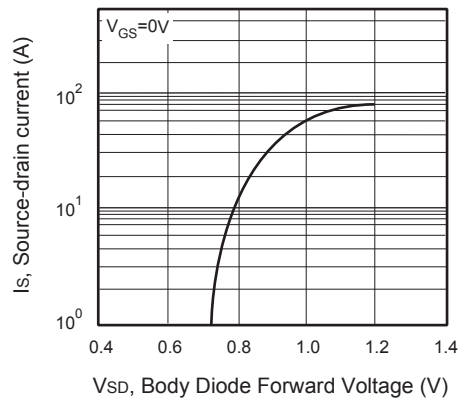

**Figure 6. Body Diode Forward Voltage Variation with Source Current**

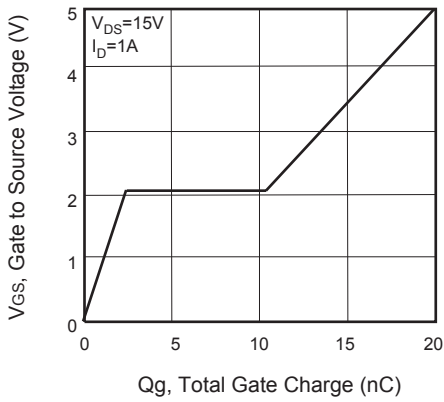

**Figure 7. Gate Charge**

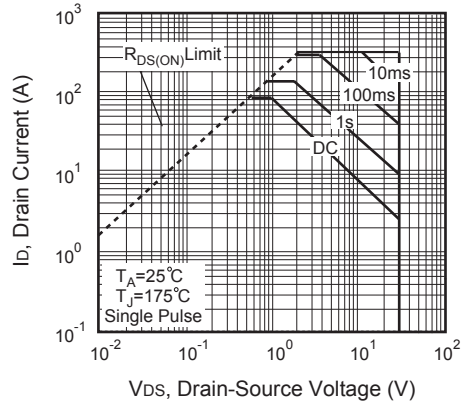

**Figure 8. Maximum Safe Operating Area**

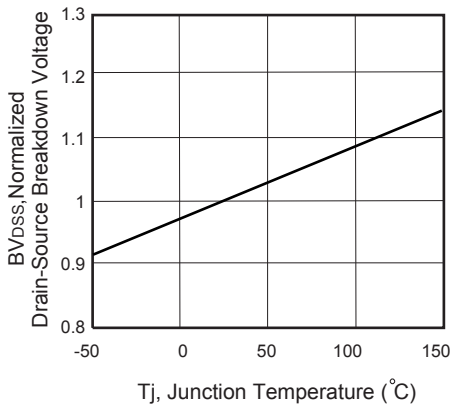

**Figure 9. Breakdown Voltage Variation VS Temperature**

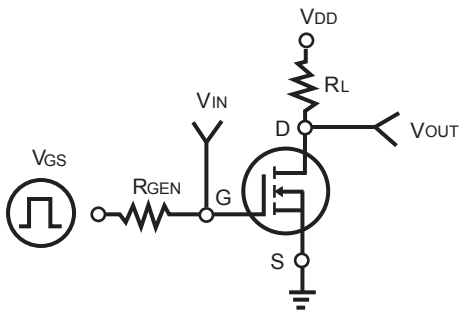

**Figure 10. Switching Test Circuit**

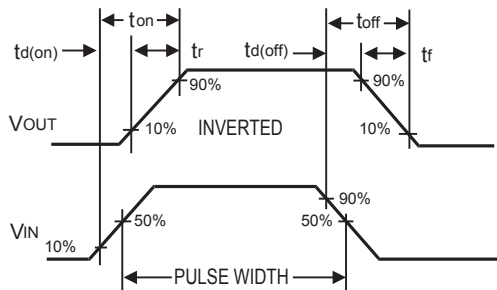

**Figure 11. Switching Waveforms**

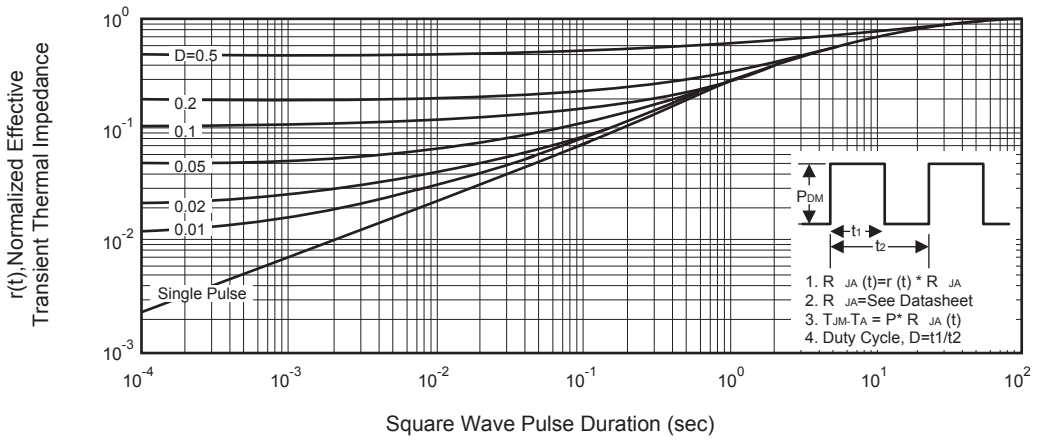

**Figure 12. Normalized Thermal Transient Impedance Curve**