



# CED02N7G-1/CEU02N7G-1

## N-Channel Enhancement Mode Field Effect Transistor

### FEATURES

- 720V, 1.6A,  $R_{DS(ON)} = 6.75\Omega$  @  $V_{GS} = 10V$ .  
750V@ $T_C=150^\circ C$
- Super high dense cell design for extremely low  $R_{DS(ON)}$ .
- High power and current handing capability.
- Lead free product is acquired.
- TO-251 & TO-252 package.



### ABSOLUTE MAXIMUM RATINGS $T_C = 25^\circ C$ unless otherwise noted

Parameter	Symbol	Limit	Units
Drain-Source Voltage	$V_{DS}$	720 ( $T_C=25^\circ C$ )	V
		750 ( $T_C=150^\circ C$ )	V
Gate-Source Voltage	$V_{GS}$	$\pm 30$	V
Drain Current-Continuous @ $T_C = 25^\circ C$ @ $T_C = 100^\circ C$	$I_D$	1.6	A
		1.1	A
Drain Current-Pulsed <sup>a</sup>	$I_{DM}$	6.4	A
Maximum Power Dissipation @ $T_C = 25^\circ C$ - Derate above $25^\circ C$	$P_D$	48	W
		0.38	W/ $^\circ C$
Single Pulsed Avalanche Energy <sup>d</sup>	$E_{AS}$	11.25	mJ
Single Pulsed Avalanche Current <sup>d</sup>	$I_{AS}$	1.5	A
Operating and Store Temperature Range	$T_J, T_{stg}$	-55 to 150	$^\circ C$

### Thermal Characteristics

Parameter	Symbol	Limit	Units
Thermal Resistance, Junction-to-Case	$R_{\theta JC}$	2.6	$^\circ C/W$
Thermal Resistance, Junction-to-Ambient	$R_{\theta JA}$	50	$^\circ C/W$



# CED02N7G-1/CEU02N7G-1

## Electrical Characteristics $T_C = 25^\circ\text{C}$ unless otherwise noted

Parameter	Symbol	Test Condition	Min	Typ	Max	Units
<b>Off Characteristics</b>						
Drain-Source Breakdown Voltage	$BV_{DSS}$	$T_C=25^\circ\text{C}, V_{GS} = 0\text{V}, I_D = 250\mu\text{A}$	720			V
		$T_C=150^\circ\text{C}, V_{GS} = 0\text{V}, I_D = 250\mu\text{A}$	750			
Zero Gate Voltage Drain Current	$I_{DSS}$	$V_{DS} = 700\text{V}, V_{GS} = 0\text{V}$			25	$\mu\text{A}$
Gate Body Leakage Current, Forward	$I_{GSSF}$	$V_{GS} = 30\text{V}, V_{DS} = 0\text{V}$			100	nA
Gate Body Leakage Current, Reverse	$I_{GSSR}$	$V_{GS} = -30\text{V}, V_{DS} = 0\text{V}$			-100	nA
<b>On Characteristics<sup>b</sup></b>						
Gate Threshold Voltage	$V_{GS(th)}$	$V_{GS} = V_{DS}, I_D = 250\mu\text{A}$	2		4	V
Static Drain-Source On-Resistance	$R_{DS(on)}$	$V_{GS} = 10\text{V}, I_D = 1\text{A}$		5.4	6.75	$\Omega$
<b>Dynamic Characteristics<sup>c</sup></b>						
Forward Transconductance	$g_{FS}$	$V_{DS} = 50\text{V}, I_D = 1\text{A}$		1.5		S
Input Capacitance	$C_{iss}$	$V_{DS} = 25\text{V}, V_{GS} = 0\text{V}, f = 1.0\text{MHz}$		315		pF
Output Capacitance	$C_{oss}$			55		pF
Reverse Transfer Capacitance	$C_{rss}$			20		pF
<b>Switching Characteristics<sup>c</sup></b>						
Turn-On Delay Time	$t_{d(on)}$	$V_{DD} = 300\text{V}, I_D = 1.9\text{A}, V_{GS} = 10\text{V}, R_{GEN} = 18\Omega$		14		ns
Turn-On Rise Time	$t_r$			12.5		ns
Turn-Off Delay Time	$t_{d(off)}$			23		ns
Turn-Off Fall Time	$t_f$			10		ns
Total Gate Charge	$Q_g$	$V_{DS} = 480\text{V}, I_D = 1.9\text{A}, V_{GS} = 10\text{V}$		9		nC
Gate-Source Charge	$Q_{gs}$			1.5		nC
Gate-Drain Charge	$Q_{gd}$			5		nC
<b>Drain-Source Diode Characteristics and Maximum Ratings</b>						
Drain-Source Diode Forward Current	$I_S$				1.6	A
Drain-Source Diode Forward Voltage <sup>b</sup>	$V_{SD}$	$V_{GS} = 0\text{V}, I_S = 1\text{A}$			1.5	V
<b>Notes :</b> □ a.Repetitive Rating : Pulse width limited by maximum junction temperature . b.Pulse Test : Pulse Width $\leq 300\mu\text{s}$ , Duty Cycle $\leq 2\%$ . □ c.Guaranteed by design, not subject to production testing. □ d.L =10mH, $I_{AS} = 1.5\text{A}$ , $V_{DD} = 50\text{V}$ , $R_G = 25\Omega$ , Starting $T_J = 25^\circ\text{C}$						

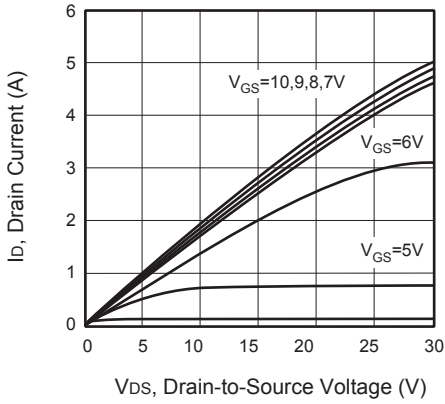

**Figure 1. Output Characteristics**

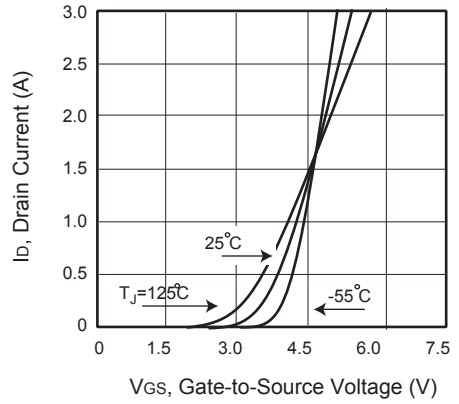

**Figure 2. Transfer Characteristics**

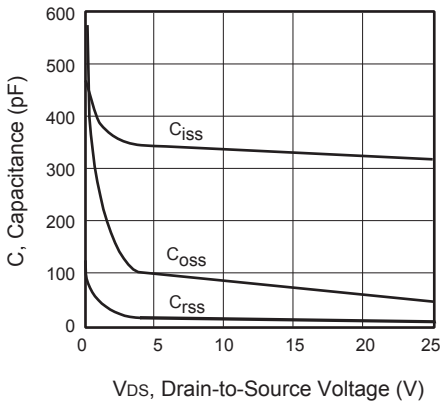

**Figure 3. Capacitance**

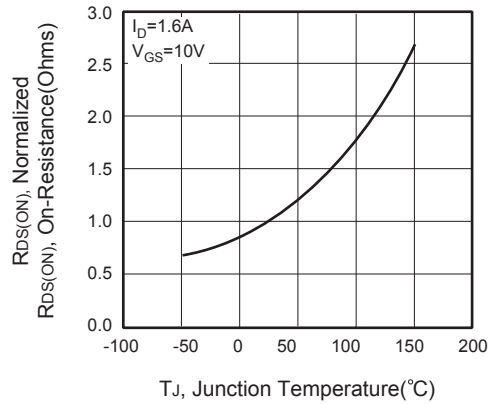

**Figure 4. On-Resistance Variation with Temperature**



**Figure 5. Gate Threshold Variation with Temperature**

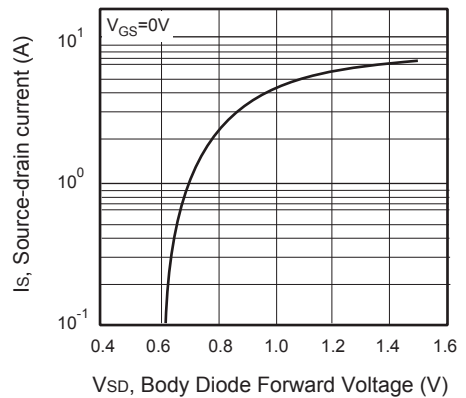

**Figure 6. Body Diode Forward Voltage Variation with Source Current**

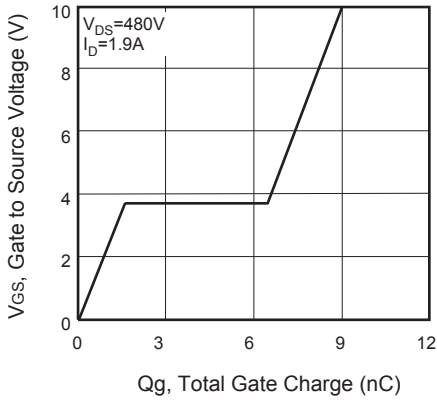

Figure 7. Gate Charge

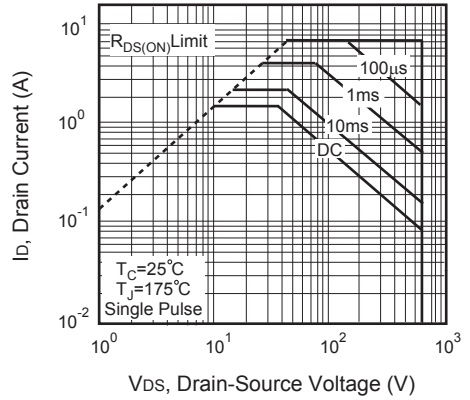

Figure 8. Maximum Safe Operating Area

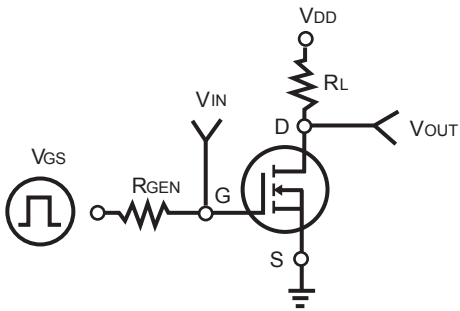

Figure 9. Switching Test Circuit

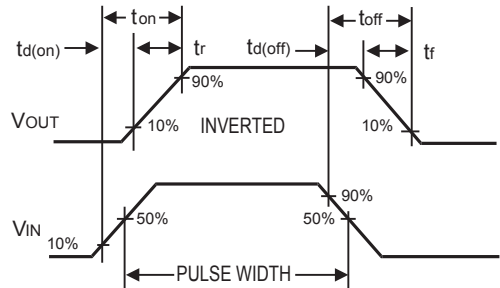

Figure 10. Switching Waveforms

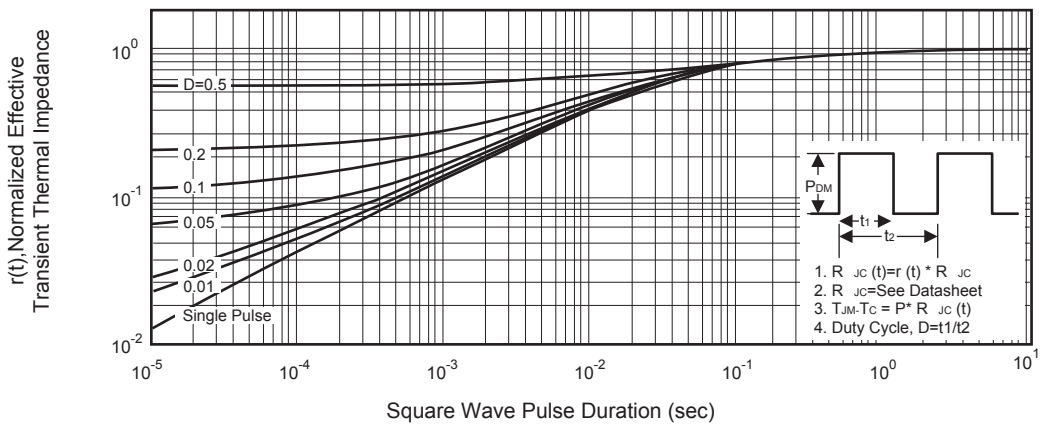

Figure 11. Normalized Thermal Transient Impedance Curve