

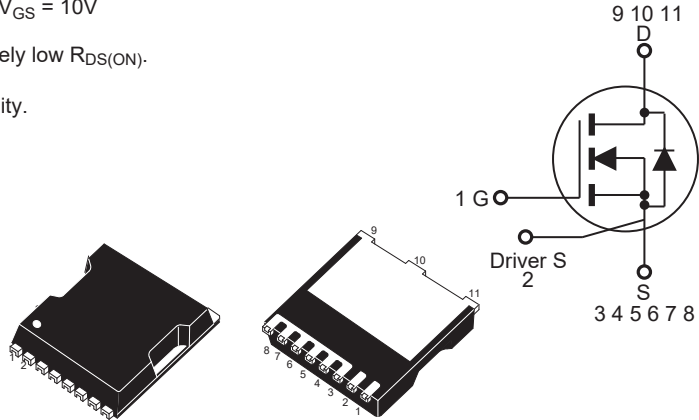
## N-Channel Enhancement Mode Field Effect Transistor

### FEATURES

- 700V@ $T_{J\max}$ , 43A,  $R_{DS(ON)} = 95m\Omega @ V_{GS} = 10V$
- Super high dense cell design for extremely low  $R_{DS(ON)}$ .
- High power and current handling capability.
- Pb-free lead plating ;RoHS compliant.
- Halogen Free.
- TOLL package.

### Applications

- EV Charging.
- Telecom.
- Server.
- Solar.
- SMPS.



### ABSOLUTE MAXIMUM RATINGS $T_C = 25^\circ C$ unless otherwise noted

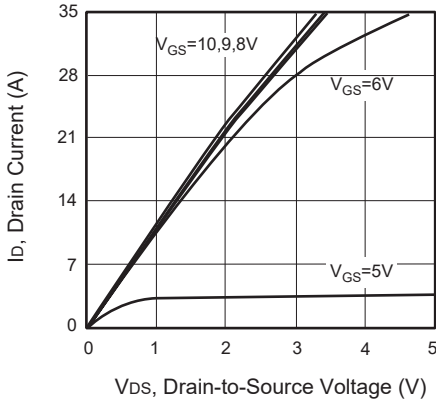
Parameter	Symbol	Limit	Units
Drain-Source Voltage	$V_{DS}$	650	V
Gate-Source Voltage	$V_{GS}$	$\pm 30$	V
Drain Current-Continuous@ $T_C = 25^\circ C$ @ $T_C = 100^\circ C$	$I_D$	43 27	A A
Drain Current-Pulsed <sup>a</sup>	$I_{DM}$	172	A
Maximum Power Dissipation @ $T_C = 25^\circ C$ - Derate above $25^\circ C$	$P_D$	446 3.5	W W/ $^\circ C$
Single Pulsed Avalanche Energy <sup>f</sup>	$E_{AS}$	735	mJ
Single Pulsed Avalanche Current <sup>f</sup>	$I_{AS}$	7	A
Operating and Store Temperature Range	$T_J, T_{stg}$	-55 to 150	$^\circ C$

### Thermal Characteristics

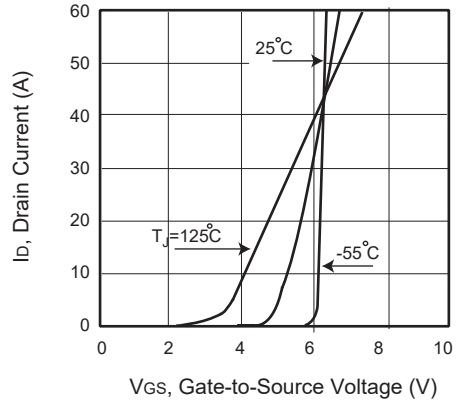
Parameter	Symbol	Limit	Units
Thermal Resistance, Junction-to-Case	$R_{\theta JC}$	0.28	$^\circ C/W$
Thermal Resistance, Junction-to-Ambient	$R_{\theta JA}$	60	$^\circ C/W$

## Electrical Characteristics $T_C = 25^\circ\text{C}$ unless otherwise noted

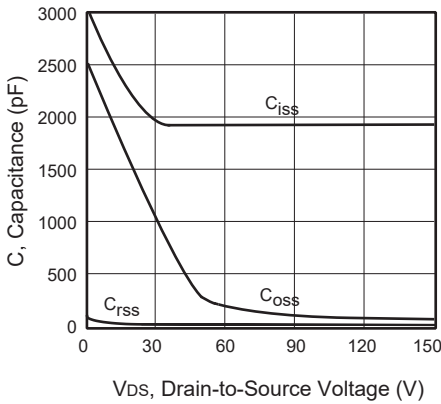
Parameter	Symbol	Test Condition	Min	Typ	Max	Units
<b>Off Characteristics</b>						
Drain-Source Breakdown Voltage	$BV_{DSS}$	$V_{GS} = 0V, I_D = 250\mu A$	650			V
Zero Gate Voltage Drain Current	$I_{DSS}$	$V_{DS} = 650V, V_{GS} = 0V$			5	$\mu A$
Gate Body Leakage Current, Forward	$I_{GSSF}$	$V_{GS} = 30V, V_{DS} = 0V$			100	nA
Gate Body Leakage Current, Reverse	$I_{GSSR}$	$V_{GS} = -30V, V_{DS} = 0V$			-100	nA
<b>On Characteristics<sup>b</sup></b>						
Gate Threshold Voltage	$V_{GS(th)}$	$V_{GS} = V_{DS}, I_D = 250\mu A$	2.5		4.5	V
Static Drain-Source On-Resistance	$R_{DS(on)}$	$V_{GS} = 10V, I_D = 20A$		80	95	m $\Omega$
Gate Input Resistance	$R_g$	f=1MHz, open Drain		3.3		$\Omega$
<b>Dynamic Characteristics<sup>c</sup></b>						
Input Capacitance	$C_{iss}$	$V_{DS} = 150V, V_{GS} = 0V,$ $f = 1MHz$		1915		pF
Output Capacitance	$C_{oss}$			110		pF
Reverse Transfer Capacitance	$C_{rss}$			5		pF
<b>Switching Characteristics<sup>c</sup></b>						
Turn-On Delay Time	$t_{d(on)}$	$V_{DD} = 520V, I_D = 20A,$ $V_{GS} = 10V, R_{GEN} = 6\Omega$		37		ns
Turn-On Rise Time	$t_r$			17		ns
Turn-Off Delay Time	$t_{d(off)}$			95		ns
Turn-Off Fall Time	$t_f$			9		ns
Total Gate Charge	$Q_g$	$V_{DS} = 520V, I_D = 20A,$ $V_{GS} = 10V$		69		nC
Gate-Source Charge	$Q_{gs}$			12		nC
Gate-Drain Charge	$Q_{gd}$			30		nC
<b>Drain-Source Diode Characteristics and Maximum Ratings</b>						
Drain-Source Diode Forward Current	$I_S$				42	A
Drain-Source Diode Forward Voltage <sup>b</sup>	$V_{SD}$	$V_{GS} = 0V, I_S = 20A$			1.5	V
Reverse Recovery Time	$T_{rr}$	$I_F = 10A, di/dt = 100A/\mu s$		324		ns
Reverse Recovery Charge	$Q_{rr}$			4.2		$\mu C$
Peak Reverse Recovery Current	$I_{rr}$			22.1		A
<b>Notes :</b> a. Repetitive Rating : Pulse width limited by maximum junction temperature. b. Pulse Test : Pulse Width $\leq 300\mu s$ , Duty Cycle $\leq 2\%$ . c. Guaranteed by design, not subject to production testing. d. L = 30mH, $I_S = 7A, V_{DD} = 50V, R_G = 25\Omega$ , Starting $T_J = 25^\circ C$ .						



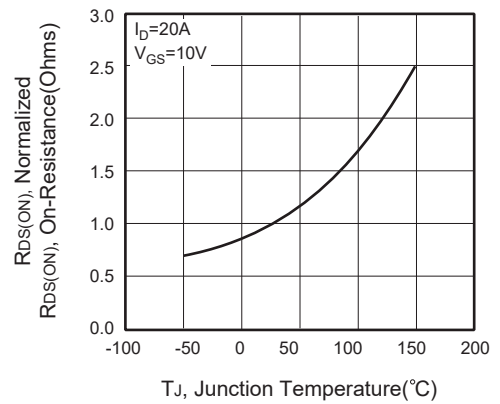
**Figure 1. Output Characteristics**



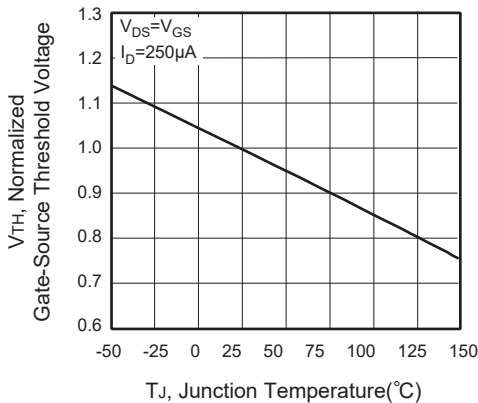
**Figure 2. Transfer Characteristics**



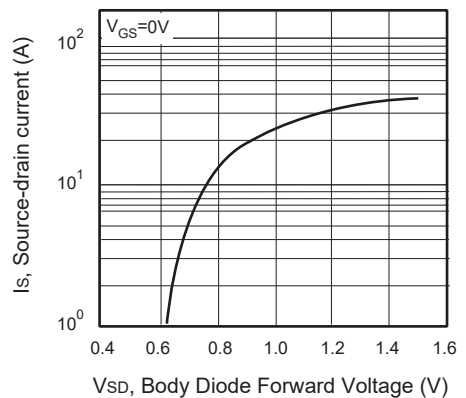
**Figure 3. Capacitance**



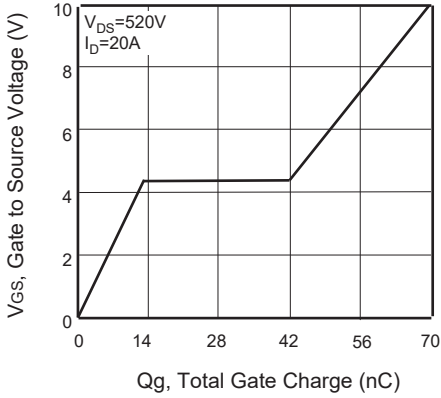
**Figure 4. On-Resistance Variation with Temperature**



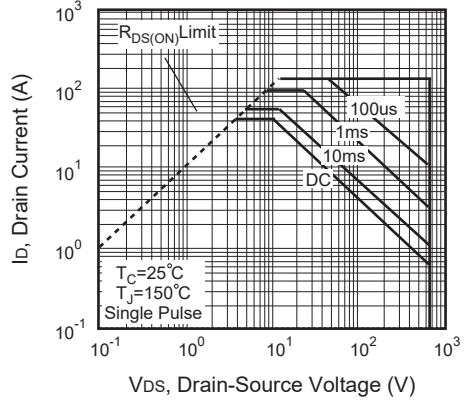
**Figure 5. Gate Threshold Variation with Temperature**



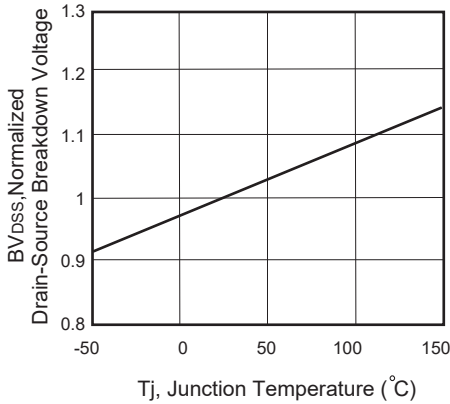
**Figure 6. Body Diode Forward Voltage Variation with Source Current**



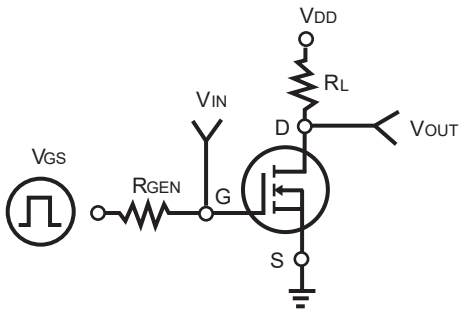
**Figure 7. Gate Charge**



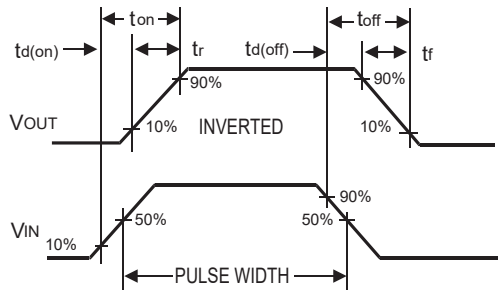
**Figure 8. Maximum Safe Operating Area**



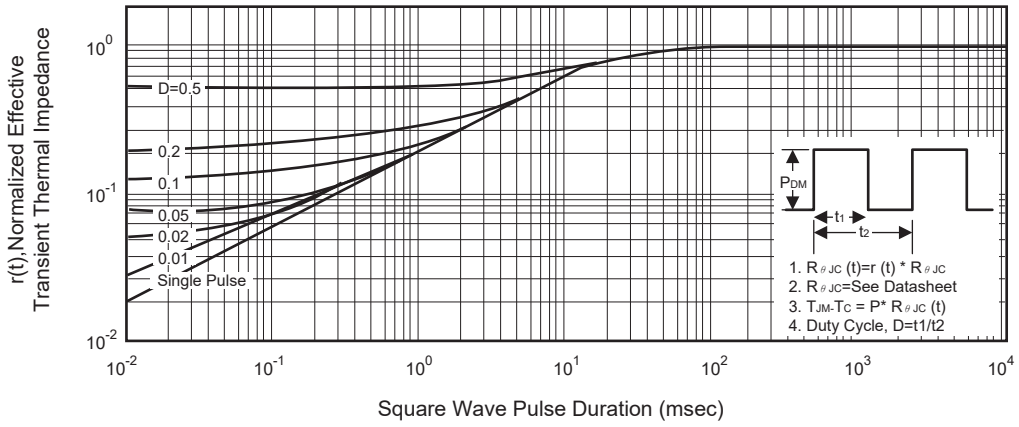
**Figure 9. Breakdown Voltage Variation VS Temperature**



**Figure 10. Switching Test Circuit**

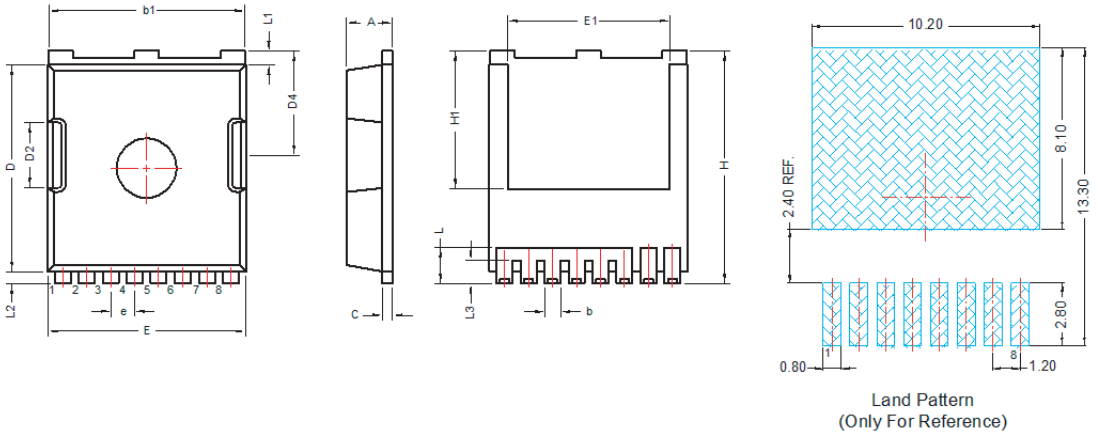


**Figure 11. Switching Waveforms**



**Figure 12. Normalized Thermal Transient Impedance Curve**

## TOLL產品外觀尺寸圖(Product Outline Dimension)



SYMBOLS	MILLIMETERS		INCHES	
	MIN	MAX	MIN	MAX
A	2.150	2.450	0.085	0.096
b	0.700	0.900	0.028	0.035
b1	9.650	9.950	0.380	0.392
c	0.400	0.600	0.016	0.024
D	10.180	10.580	0.401	0.417
D2	3.150	3.450	0.124	0.136
D4	4.400	4.700	0.173	0.185
E	9.700	10.100	0.382	0.398
E1	7.950	8.250	0.313	0.325
e	1.20BSC		0.047BSC	
H	11.480	11.880	0.452	0.468
H1	6.800	7.100	0.268	0.280
L	1.500	2.100	0.059	0.083
L1	0.500	0.900	0.020	0.035
L2	0.500	0.720	0.020	0.028
L3	1.000	1.300	0.039	0.051