

N-Channel Enhancement Mode Field Effect Transistor

PRELIMINARY

FEATURES

- High power and current handling capability.
- Reliable and rugged.
- Pb-free lead plating ; RoHS compliant.
- Halogen Free.

APPLICATIONS

- Motor control.
- Load Switch.
- Battery Management System.
- O-Ring.

V_{DSS}	$R_{DS(ON)}$ typ	I_D	@ V_{GS}
60V	0.6m Ω	550A	10V
	0.95m Ω		6V

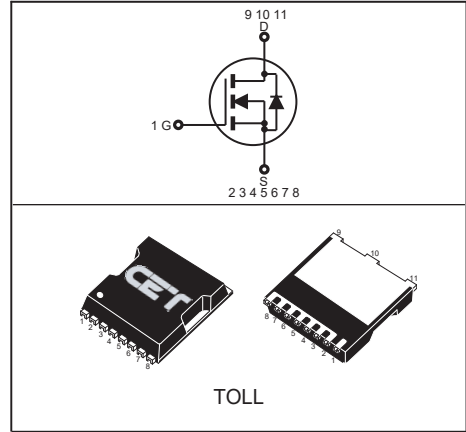

ABSOLUTE MAXIMUM RATINGS $T_C = 25^\circ\text{C}$ unless otherwise noted

Parameter	Symbol	Limit	Units
Drain-Source Voltage	V_{DS}	60	V
Gate-Source Voltage	V_{GS}	± 20	V
Drain Current-Continuous @ $T_C = 25^\circ\text{C}$ @ $T_C = 100^\circ\text{C}$	I_D	550	A
		389	A
Drain Current-Pulsed ^a	I_{DM}	2200	A
Maximum Power Dissipation @ $T_C = 25^\circ\text{C}$ - Derate above 25°C	P_D	484	W
		3.23	W/ $^\circ\text{C}$
Operating and Store Temperature Range	T_J, T_{stg}	-55 to 175	$^\circ\text{C}$

Thermal Characteristics

Parameter	Symbol	Limit	Units
Thermal Resistance, Junction-to-Case	$R_{\theta JC}$	0.31	$^\circ\text{C}/\text{W}$
Thermal Resistance, Junction-to-Ambient	$R_{\theta JA}$	60	$^\circ\text{C}/\text{W}$

Electrical Characteristics $T_C = 25^\circ\text{C}$ unless otherwise noted

Parameter	Symbol	Test Condition	Min	Typ	Max	Units
Off Characteristics						
Drain-Source Breakdown Voltage	BV_{DSS}	$V_{GS} = 0V, I_D = 250\mu A$	60			V
Zero Gate Voltage Drain Current	I_{DSS}	$V_{DS} = 60V, V_{GS} = 0V$			1	μA
Gate Body Leakage Current, Forward	I_{GSSF}	$V_{GS} = 20V, V_{DS} = 0V$			100	nA
Gate Body Leakage Current, Reverse	I_{GSSR}	$V_{GS} = -20V, V_{DS} = 0V$			-100	nA
On Characteristics^b						
Gate Threshold Voltage	$V_{GS(th)}$	$V_{GS} = V_{DS}, I_D = 250\mu A$	2		4	V
Static Drain-Source On-Resistance	$R_{DS(on)}$	$V_{GS} = 10V, I_D = 20A$		0.6	0.8	$m\Omega$
		$V_{GS} = 6V, I_D = 20A$		0.95	1.25	$m\Omega$
Gate Input Resistance	R_g	$f=1\text{MHz, open Drain}$		2.1		Ω
Dynamic Characteristics^c						
Input Capacitance	C_{iss}	$V_{DS} = 30V, V_{GS} = 0V, f = 1.0\text{ MHz}$		19695		pF
Output Capacitance	C_{oss}			5190		pF
Reverse Transfer Capacitance	C_{rss}			260		pF
Switching Characteristics^c						
Turn-On Delay Time	$t_{d(on)}$	$V_{DD} = 30V, I_D = 20A, V_{GS} = 10V, R_{GEN} = 3.9\Omega$		73		ns
Turn-On Rise Time	t_r			43		ns
Turn-Off Delay Time	$t_{d(off)}$			158		ns
Turn-Off Fall Time	t_f			77		ns
Total Gate Charge	Q_g	$V_{DS} = 30V, I_D = 20A, V_{GS} = 10V$		239		nC
Gate-Source Charge	Q_{gs}			60		nC
Gate-Drain Charge	Q_{gd}			71		nC
Drain-Source Diode Characteristics and Maximum Ratings						
Drain-Source Diode Forward Current	I_S				403	A
Drain-Source Diode Forward Voltage ^b	V_{SD}	$V_{GS} = 0V, I_S = 10A$			1.2	V
Notes : a.Repetitive Rating : Pulse width limited by maximum junction temperature b.Pulse Test : Pulse Width $\leq 300\mu s$, Duty Cycle $\leq 2\%$. c.Guaranteed by design, not subject to production testing.						

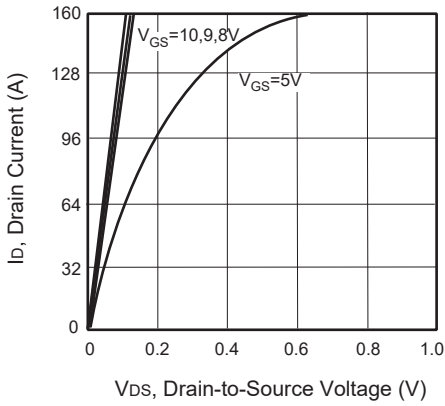

Figure 1. Output Characteristics

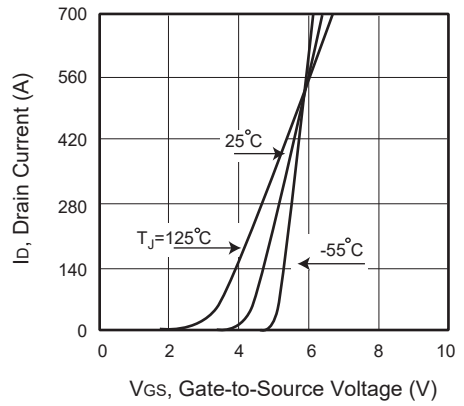

Figure 2. Transfer Characteristics

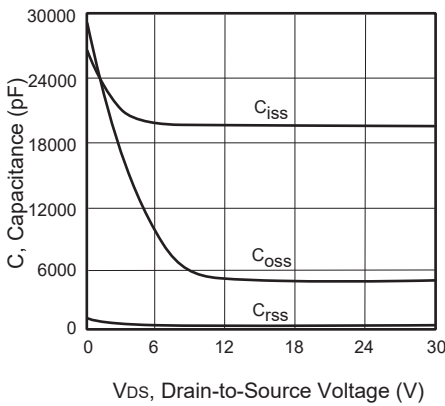

Figure 3. Capacitance

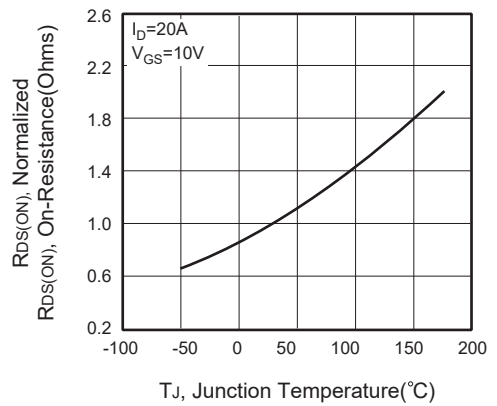

Figure 4. On-Resistance Variation with Temperature

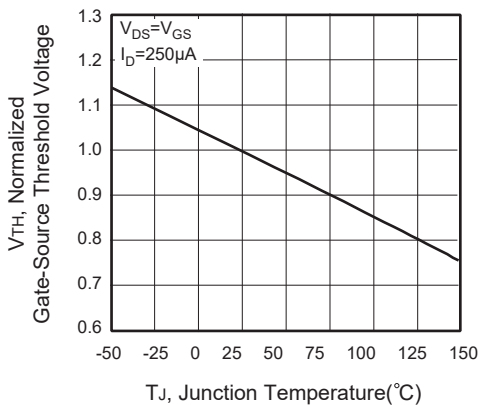

Figure 5. Gate Threshold Variation with Temperature

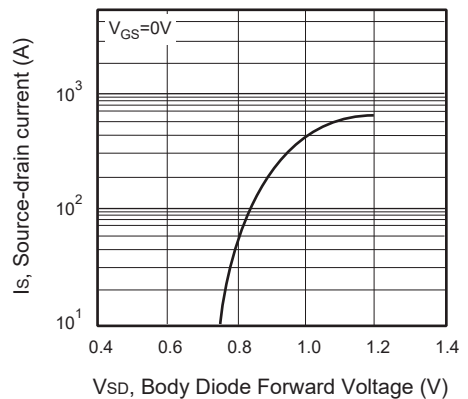

Figure 6. Body Diode Forward Voltage Variation with Source Current

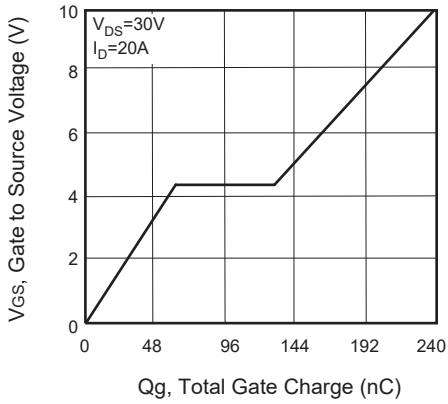

Figure 7. Gate Charge

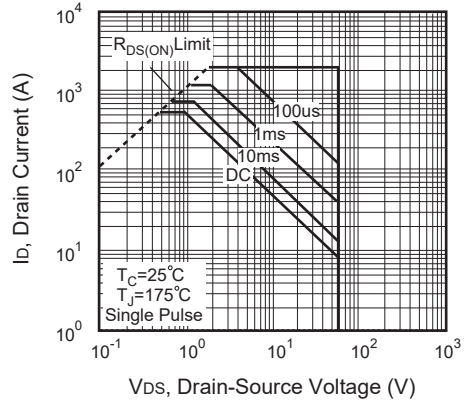

Figure 8. Maximum Safe Operating Area

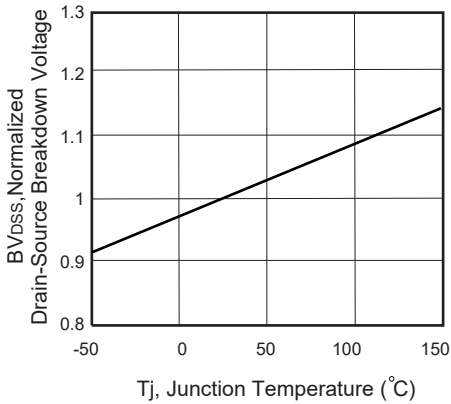

Figure 9. Breakdown Voltage Variation VS Temperature

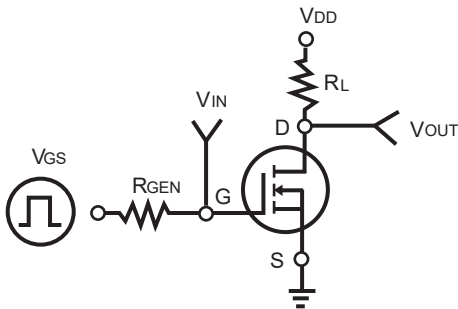

Figure 10. Switching Test Circuit



Figure 11. Switching Waveforms

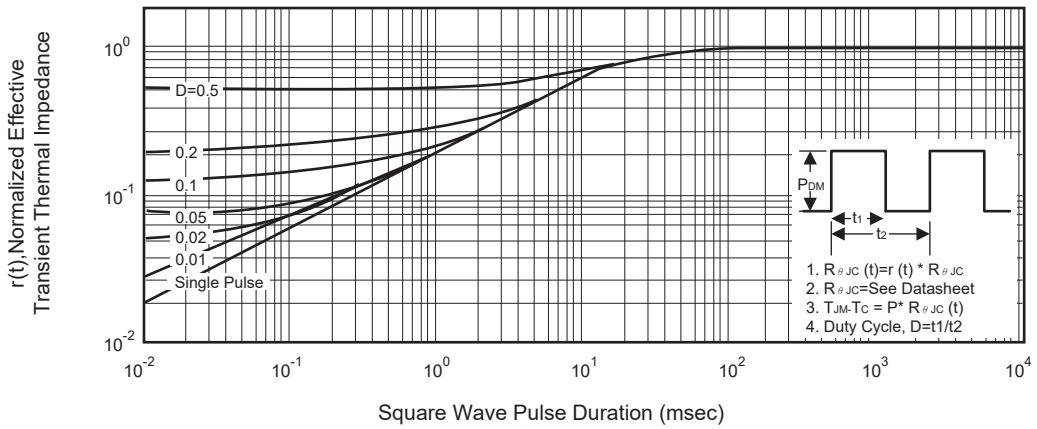
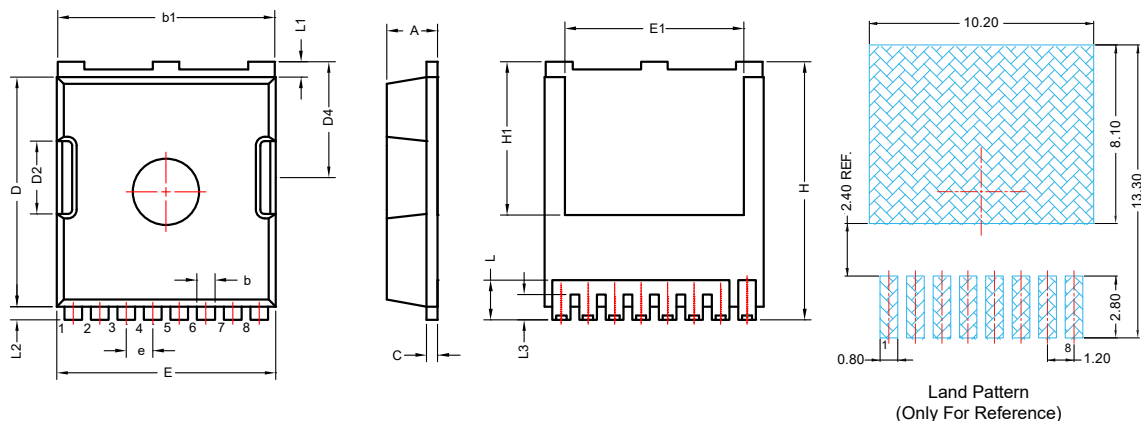

Figure 12. Normalized Thermal Transient Impedance Curve

TOLL 產品外觀尺寸圖 (Product Outline Dimension)



SYMBOLS	MILLIMETERS		INCHES	
	MIN	MAX	MIN	MAX
A	2.150	2.450	0.085	0.096
b	0.700	0.900	0.028	0.035
b1	9.650	9.950	0.380	0.392
c	0.400	0.600	0.016	0.024
D	10.180	10.580	0.401	0.417
D2	3.150	3.450	0.124	0.136
D4	4.400	4.700	0.173	0.185
E	9.700	10.100	0.382	0.398
E1	7.950	8.250	0.313	0.325
e	1.20BSC		0.047BSC	
H	11.480	11.880	0.452	0.468
H1	6.800	7.100	0.268	0.280
L	1.500	2.100	0.059	0.083
L1	0.500	0.900	0.020	0.035
L2	0.500	0.720	0.020	0.028
L3	1.000	1.300	0.039	0.051