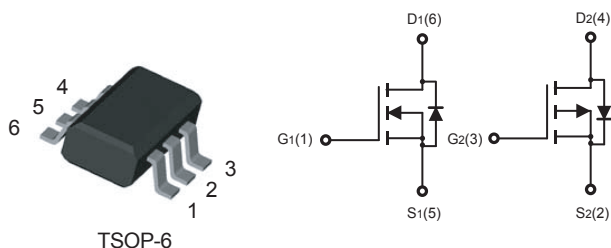


## Dual Enhancement Mode Field Effect Transistor (N and P Channel)

### FEATURES

- 20V, 3.5A,  $R_{DS(ON)} = 60m\Omega$  @ $V_{GS} = 4.5V$ .  
 $R_{DS(ON)} = 80m\Omega$  @ $V_{GS} = 2.5V$ .
- -20V, -2.5A,  $R_{DS(ON)} = 100m\Omega$  @ $V_{GS} = -4.5V$ .  
 $R_{DS(ON)} = 145m\Omega$  @ $V_{GS} = -2.5V$ .
- Super high dense cell design for extremely low  $R_{DS(ON)}$ .
- High power and current handling capability.
- Lead free product is acquired.
- Surface mount Package.



### ABSOLUTE MAXIMUM RATINGS $T_A = 25^\circ C$ unless otherwise noted

Parameter	Symbol	N-Channel	P-Channel	Units
Drain-Source Voltage	$V_{DS}$	20	-20	V
Gate-Source Voltage	$V_{GS}$	$\pm 12$	$\pm 12$	V
Drain Current-Continuous	$I_D$	3.5	-2.5	A
Drain Current-Pulsed <sup>a</sup>	$I_{DM}$	14	10	A
Maximum Power Dissipation	$P_D$	1.14		W
Operating and Store Temperature Range	$T_J, T_{stg}$	-55 to 150		$^\circ C$

### Thermal Characteristics

Parameter	Symbol	Limit	Units
Thermal Resistance, Junction-to-Ambient <sup>b</sup>	$R_{\theta JA}$	110	$^\circ C/W$

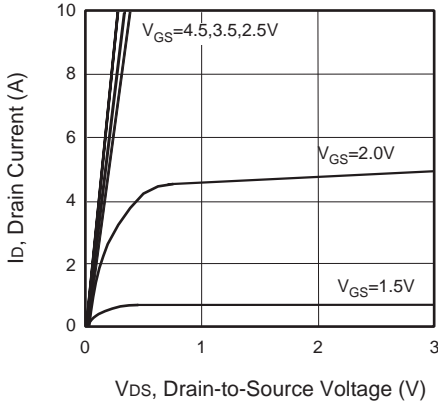
## N-Channel Electrical Characteristics $T_A = 25^\circ\text{C}$ unless otherwise noted

Parameter	Symbol	Test Condition	Min	Typ	Max	Units
<b>Off Characteristics</b>						
Drain-Source Breakdown Voltage	$BV_{DSS}$	$V_{GS} = 0V, I_D = 250\mu A$	20			V
Zero Gate Voltage Drain Current	$I_{DSS}$	$V_{DS} = 20V, V_{GS} = 0V$			1	$\mu A$
Gate Body Leakage Current, Forward	$I_{GSSF}$	$V_{GS} = 12V, V_{DS} = 0V$			100	nA
Gate Body Leakage Current, Reverse	$I_{GSSR}$	$V_{GS} = -12V, V_{DS} = 0V$			-100	nA
<b>On Characteristics<sup>c</sup></b>						
Gate Threshold Voltage	$V_{GS(th)}$	$V_{GS} = V_{DS}, I_D = 250\mu A$	0.4		1.2	V
Static Drain-Source On-Resistance	$R_{DS(on)}$	$V_{GS} = 4.5V, I_D = 3.5A$		40	60	$m\Omega$
		$V_{GS} = 2.5V, I_D = 2.0A$		50	80	$m\Omega$
<b>Dynamic Characteristics<sup>d</sup></b>						
Input Capacitance	$C_{iss}$	$V_{DS} = 10V, V_{GS} = 0V, f = 1.0\text{ MHz}$		380		pF
Output Capacitance	$C_{oss}$			90		pF
Reverse Transfer Capacitance	$C_{rss}$			60		pF
<b>Switching Characteristics<sup>d</sup></b>						
Turn-On Delay Time	$t_{d(on)}$	$V_{DD} = 10V, I_D = 3.5A, V_{GS} = 4.5V, R_{GEN} = 6\Omega$		16		ns
Turn-On Rise Time	$t_r$			16		ns
Turn-Off Delay Time	$t_{d(off)}$			32		ns
Turn-Off Fall Time	$t_f$			7		ns
Total Gate Charge	$Q_g$	$V_{DS} = 10V, I_D = 3.5A, V_{GS} = 3.3V$		3.6		nC
Gate-Source Charge	$Q_{gs}$			1.0		nC
Gate-Drain Charge	$Q_{gd}$			1.2		nC
<b>Drain-Source Diode Characteristics and Maximum Ratings</b>						
Drain-Source Diode Forward Current <sup>b</sup>	$I_S$				1	A
Drain-Source Diode Forward Voltage <sup>c</sup>	$V_{SD}$	$V_{GS} = 0V, I_S = 1A$			1.1	V
<b>Notes :</b> a.Repetitive Rating : Pulse width limited by maximum junction temperature. b.Surface Mounted on FR4 Board, $t \leq 10$ sec. c.Pulse Test : Pulse Width $\leq 300\mu s$ , Duty Cycle $\leq 2\%$ . d.Guaranteed by design, not subject to production testing.						

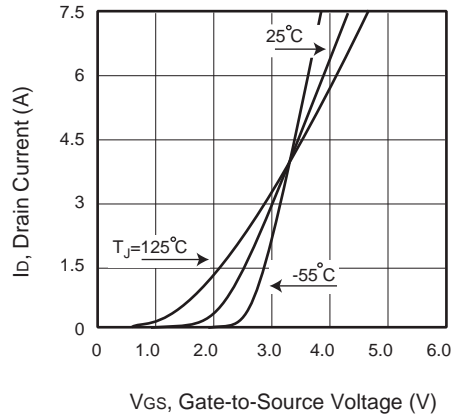
## P-CHANNEL Electrical Characteristics $T_A = 25^\circ\text{C}$ unless otherwise noted

Parameter	Symbol	Test Condition	Min	Typ	Max	Units
<b>Off Characteristics</b>						
Drain-Source Breakdown Voltage	$BV_{DSS}$	$V_{GS} = 0V, I_D = -250\mu A$	-20			V
Zero Gate Voltage Drain Current	$I_{DSS}$	$V_{DS} = -16V, V_{GS} = 0V$			-1	$\mu A$
Gate Body Leakage Current, Forward	$I_{GSSF}$	$V_{GS} = 12V, V_{DS} = 0V$			100	nA
Gate Body Leakage Current, Reverse	$I_{GSSR}$	$V_{GS} = -12V, V_{DS} = 0V$			-100	nA
<b>On Characteristics<sup>c</sup></b>						
Gate Threshold Voltage	$V_{GS(th)}$	$V_{GS} = V_{DS}, I_D = -250\mu A$	-0.4		-1.2	V
Static Drain-Source On-Resistance	$R_{DS(on)}$	$V_{GS} = -4.5V, I_D = -2.5A$		75	100	$m\Omega$
		$V_{GS} = -2.5V, I_D = -1.5A$		100	145	$m\Omega$
<b>Dynamic Characteristics<sup>d</sup></b>						
Input Capacitance	$C_{iss}$	$V_{DS} = -10V, V_{GS} = 0V,$ $f = 1.0\text{ MHz}$		375		pF
Output Capacitance	$C_{oss}$			90		pF
Reverse Transfer Capacitance	$C_{rss}$			60		pF
<b>Switching Characteristics<sup>d</sup></b>						
Turn-On Delay Time	$t_{d(on)}$	$V_{DD} = -10V, I_D = -2.5A,$ $V_{GS} = -4.5V, R_{GEN} = 3\Omega$		17		ns
Turn-On Rise Time	$t_r$			17		ns
Turn-Off Delay Time	$t_{d(off)}$			27		ns
Turn-Off Fall Time	$t_f$			7		ns
Total Gate Charge	$Q_g$	$V_{DS} = -10V, I_D = -2.0A,$ $V_{GS} = -3.3V$		2.9		nC
Gate-Source Charge	$Q_{gs}$			0.46		nC
Gate-Drain Charge	$Q_{gd}$			1.19		nC
<b>Drain-Source Diode Characteristics and Maximum Ratings</b>						
Drain-Source Diode Forward Current <sup>b</sup>	$I_S$				-1	A
Drain-Source Diode Forward Voltage <sup>c</sup>	$V_{SD}$	$V_{GS} = 0V, I_S = -1A$			-1.1	V
<b>Notes :</b> a.Repetitive Rating : Pulse width limited by maximum junction temperature. b.Surface Mounted on FR4 Board, $t < 5$ sec. c.Pulse Test : Pulse Width $\leq 300\mu s$ , Duty Cycle $\leq 2\%$ . d.Guaranteed by design, not subject to production testing.						

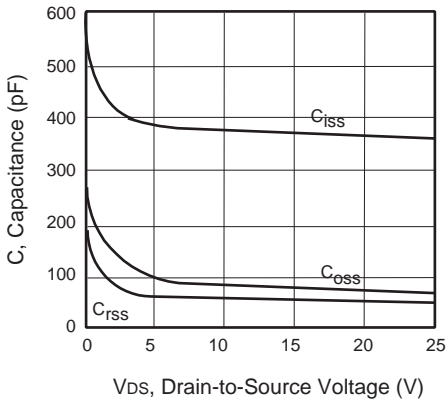
## N-CHANNEL



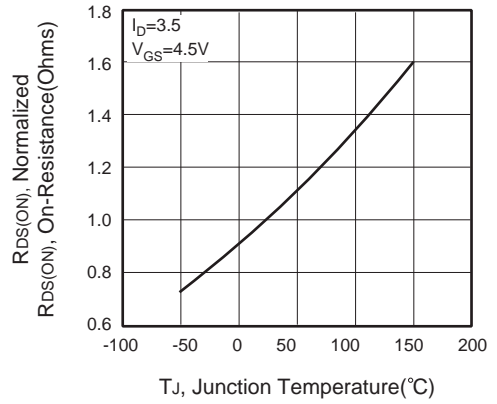
**Figure 1. Output Characteristics**



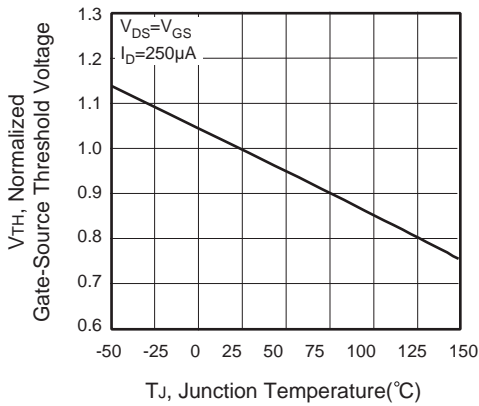
**Figure 2. Transfer Characteristics**



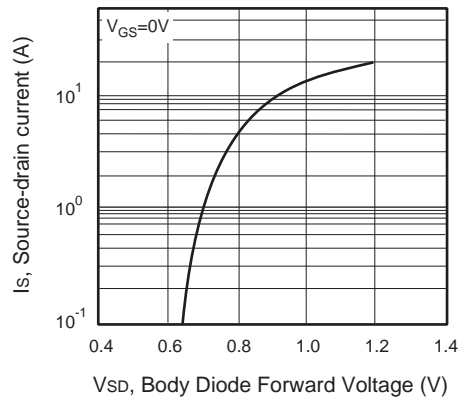
**Figure 3. Capacitance**



**Figure 4. On-Resistance Variation with Temperature**

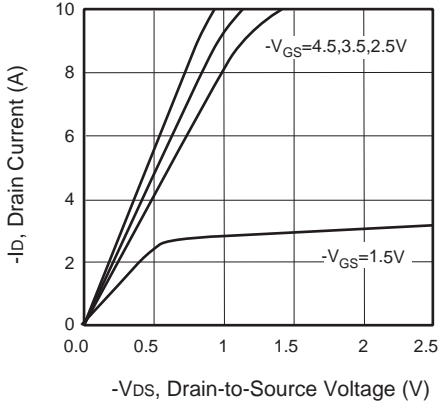


**Figure 5. Gate Threshold Variation with Temperature**

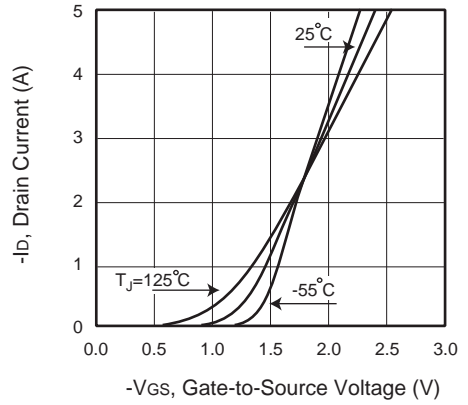


**Figure 6. Body Diode Forward Voltage Variation with Source Current**

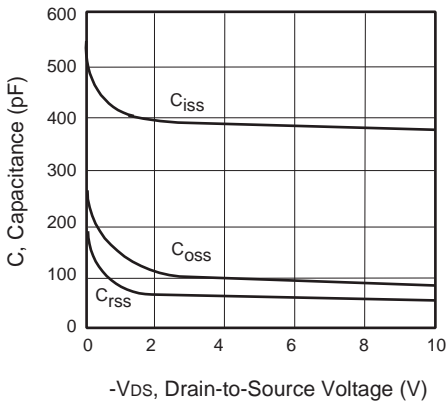
## P-CHANNEL



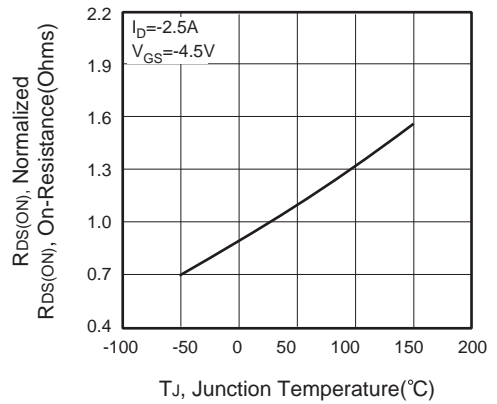
**Figure 7. Output Characteristics**



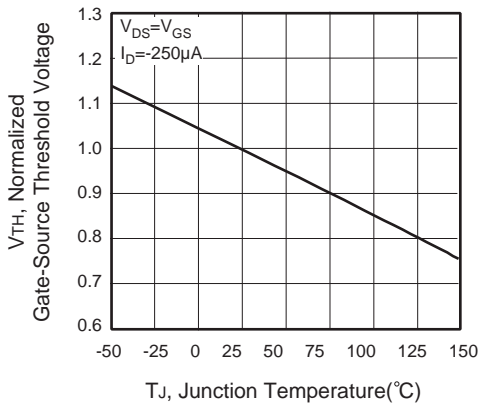
**Figure 8. Transfer Characteristics**



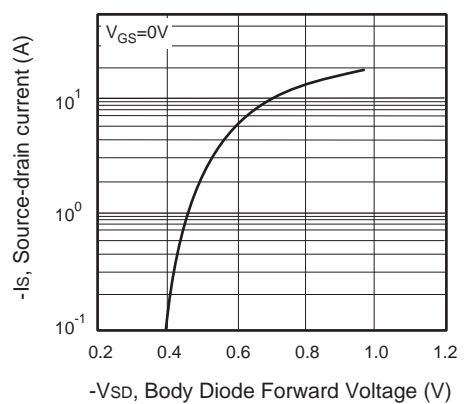
**Figure 9. Capacitance**



**Figure 10. On-Resistance Variation with Temperature**



**Figure 11. Gate Threshold Variation with Temperature**



**Figure 12. Body Diode Forward Voltage Variation with Source Current**

## N-CHANNEL

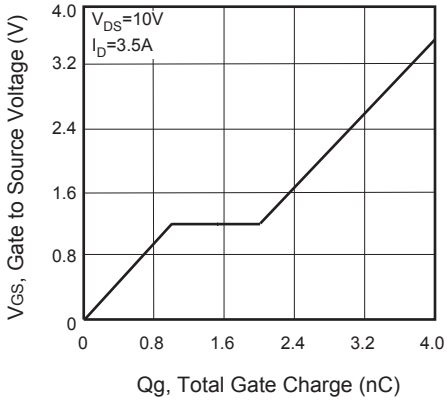


Figure 13. Gate Charge

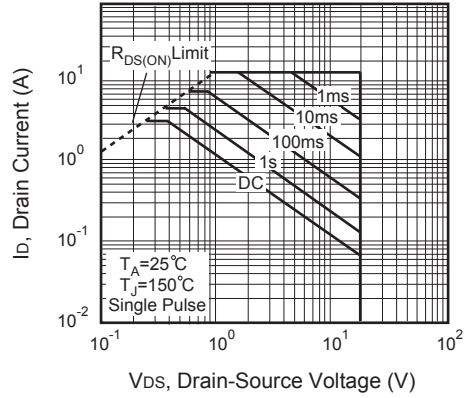


Figure 14. Maximum Safe Operating Area

## P-CHANNEL

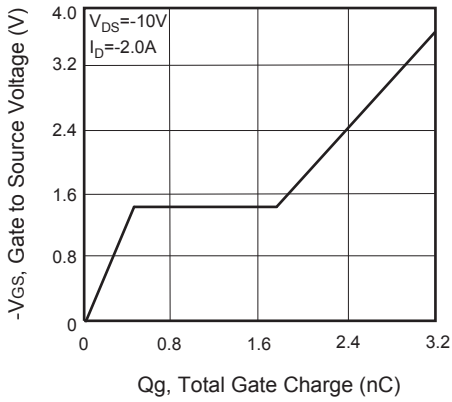


Figure 15. Gate Charge

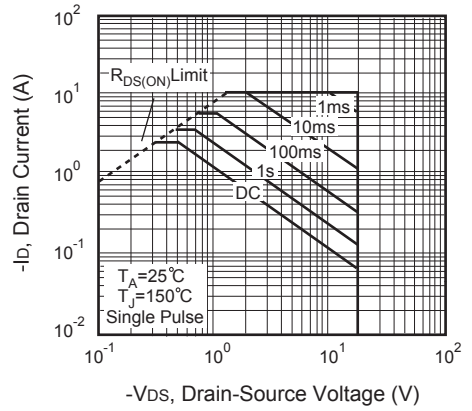


Figure 16. Maximum Safe Operating Area

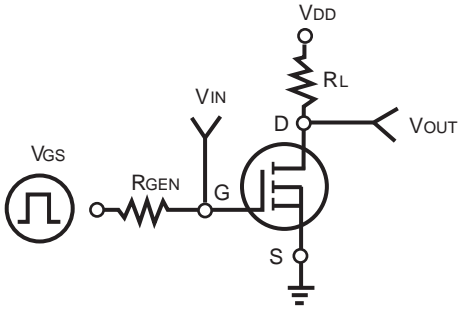


Figure 17. Switching Test Circuit

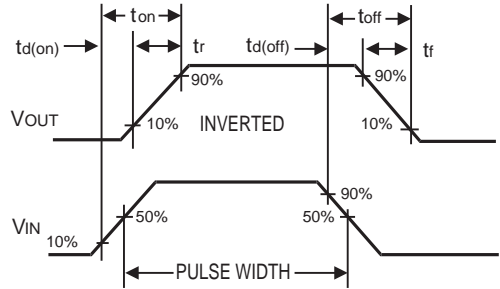


Figure 18. Switching Waveforms

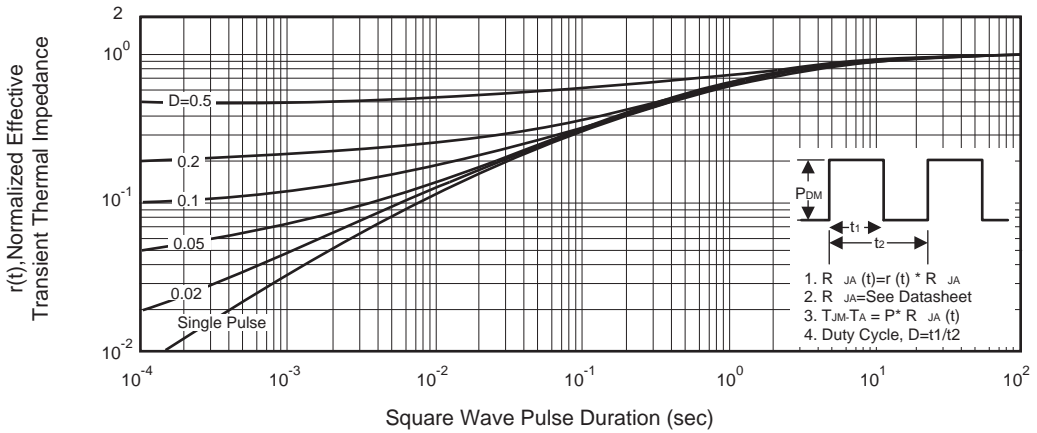


Figure 19. Normalized Thermal Transient Impedance Curve