

## Dual Enhancement Mode Field Effect Transistor (P Channel)

### FEATURES

- -20V, -3.0A,  $R_{DS(ON)} = 70m\Omega$  @ $V_{GS} = -4.5V$ .  
 $R_{DS(ON)} = 90m\Omega$  @ $V_{GS} = -2.5V$ .  
 $R_{DS(ON)} = 120m\Omega$  @ $V_{GS} = -1.8V$ .
- High dense cell design for extremely low  $R_{DS(ON)}$ .
- Rugged and reliable.
- Lead-free plating ; RoHS compliant.
- TSOP-6 package.

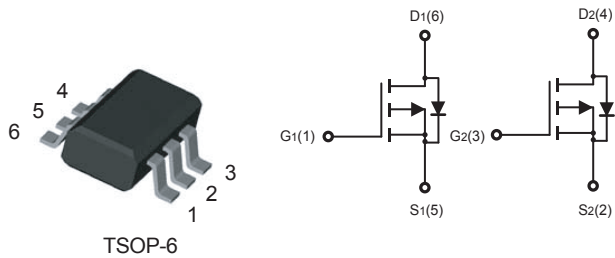

### ABSOLUTE MAXIMUM RATINGS $T_A = 25^\circ C$ unless otherwise noted

Parameter	Symbol	Limit	Units
Drain-Source Voltage	$V_{DS}$	-20	V
Gate-Source Voltage	$V_{GS}$	$\pm 12$	V
Drain Current-Continuous	$I_D$	-3	A
Drain Current-Pulsed <sup>a</sup>	$I_{DM}$	-12	A
Maximum Power Dissipation	$P_D$	1.14	W
Operating and Store Temperature Range	$T_J, T_{stg}$	-55 to 150	$^\circ C$

### Thermal Characteristics

Parameter	Symbol	Limit	Units
Thermal Resistance, Junction-to-Ambient <sup>b</sup>	$R_{\theta JA}$	110	$^\circ C/W$

## Electrical Characteristics $T_A = 25^\circ\text{C}$ unless otherwise noted

Parameter	Symbol	Test Condition	Min	Typ	Max	Units
<b>Off Characteristics</b>						
Drain-Source Breakdown Voltage	$BV_{DSS}$	$V_{GS} = 0V, I_D = -250\mu A$	-20			V
Zero Gate Voltage Drain Current	$I_{DSS}$	$V_{DS} = -20V, V_{GS} = 0V$			-1	$\mu A$
Gate Body Leakage Current, Forward	$I_{GSSF}$	$V_{GS} = 12V, V_{DS} = 0V$			100	nA
Gate Body Leakage Current, Reverse	$I_{GSSR}$	$V_{GS} = -12V, V_{DS} = 0V$			-100	nA
<b>On Characteristics <sup>c</sup></b>						
Gate Threshold Voltage	$V_{GS(th)}$	$V_{GS} = V_{DS}, I_D = -250\mu A$	-0.4		-1	V
Static Drain-Source On-Resistance	$R_{DS(on)}$	$V_{GS} = -4.5V, I_D = -3.0A$		55	70	$m\Omega$
		$V_{GS} = -2.5V, I_D = -2.0A$		67	90	$m\Omega$
		$V_{GS} = -1.8V, I_D = -1.0A$		78	120	$m\Omega$
<b>Dynamic Characteristics <sup>d</sup></b>						
Input Capacitance	$C_{iss}$	$V_{DS} = -15V, V_{GS} = 0V,$ $f = 1.0\text{ MHz}$		700		pF
Output Capacitance	$C_{oss}$			75		pF
Reverse Transfer Capacitance	$C_{rss}$			50		pF
<b>Switching Characteristics <sup>d</sup></b>						
Turn-On Delay Time	$t_{d(on)}$	$V_{DD} = -15V, I_D = -3A,$ $V_{GS} = -4.5V, R_{GEN} = 6\Omega$		11		ns
Turn-On Rise Time	$t_r$			8		ns
Turn-Off Delay Time	$t_{d(off)}$			85		ns
Turn-Off Fall Time	$t_f$			27		ns
Total Gate Charge	$Q_g$	$V_{DS} = -15V, I_D = -3.0A,$ $V_{GS} = -4.5V$		8		nC
Gate-Source Charge	$Q_{gs}$			1.4		nC
Gate-Drain Charge	$Q_{gd}$			1.9		nC
<b>Drain-Source Diode Characteristics and Maximum Ratings</b>						
Drain-Source Diode Forward Current <sup>b</sup>	$I_S$				-1.0	A
Drain-Source Diode Forward Voltage <sup>c</sup>	$V_{SD}$	$V_{GS} = 0V, I_S = -1.0A$			-1.0	V
<b>Notes :</b> □ a.Repetitive Rating : Pulse width limited by maximum junction temperature.□ b.Surface Mounted on FR4 Board, $t < 5\text{ sec.}$ □ c.Pulse Test : Pulse Width $\leq 300\mu s$ , Duty Cycle $\leq 2\%$ .□ d.Guaranteed by design, not subject to production testing.□ □						

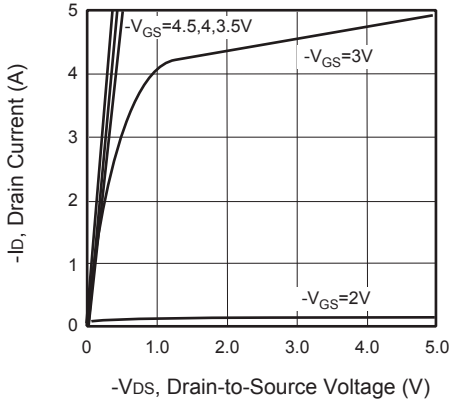

**Figure 1. Output Characteristics**

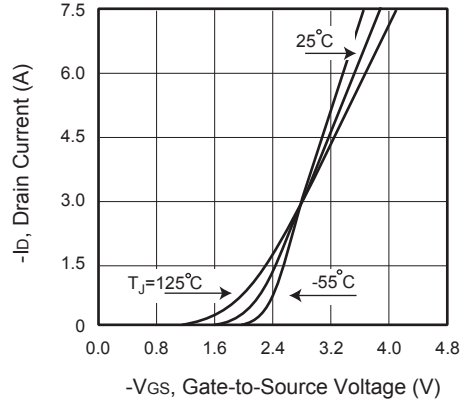

**Figure 2. Transfer Characteristics**

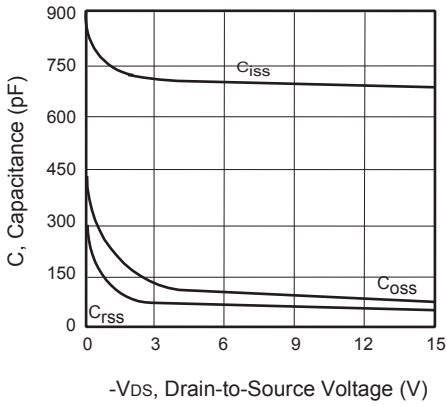

**Figure 3. Capacitance**

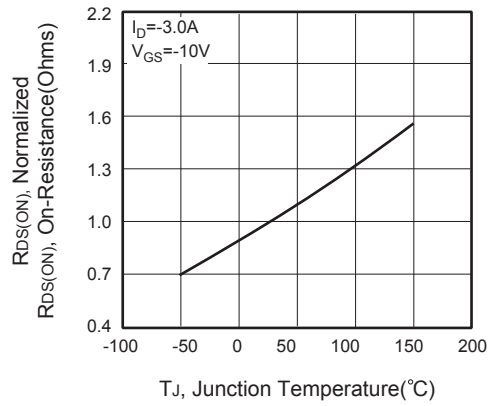

**Figure 4. On-Resistance Variation with Temperature**

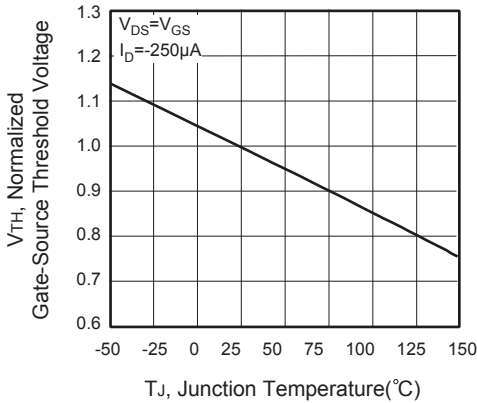

**Figure 5. Gate Threshold Variation with Temperature**

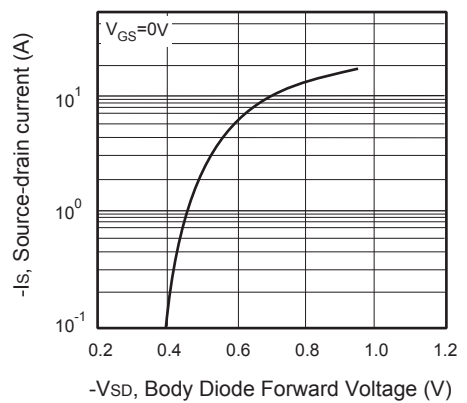

**Figure 6. Body Diode Forward Voltage Variation with Source Current**

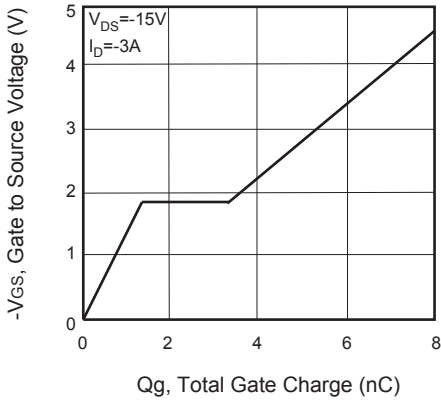

Figure 7. Gate Charge

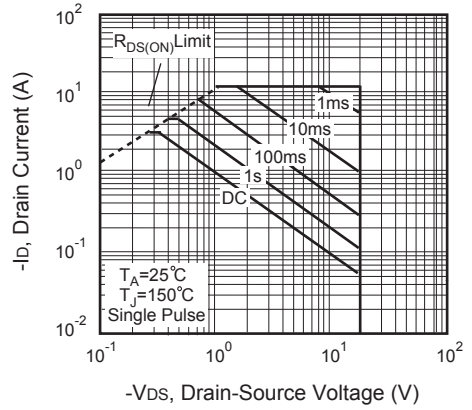

Figure 8. Maximum Safe Operating Area

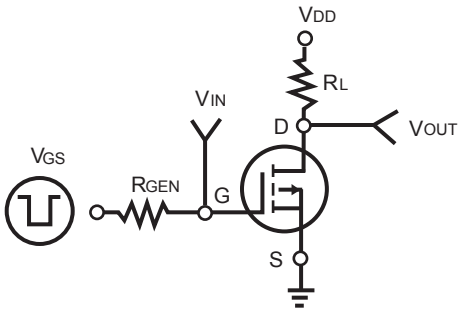

Figure 9. Switching Test Circuit

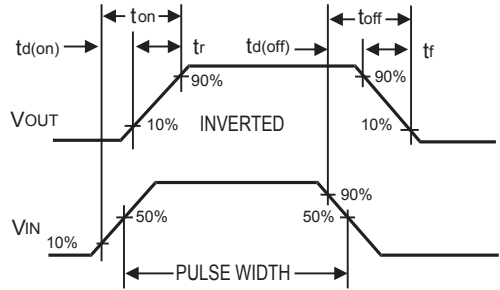

Figure 10. Switching Waveforms

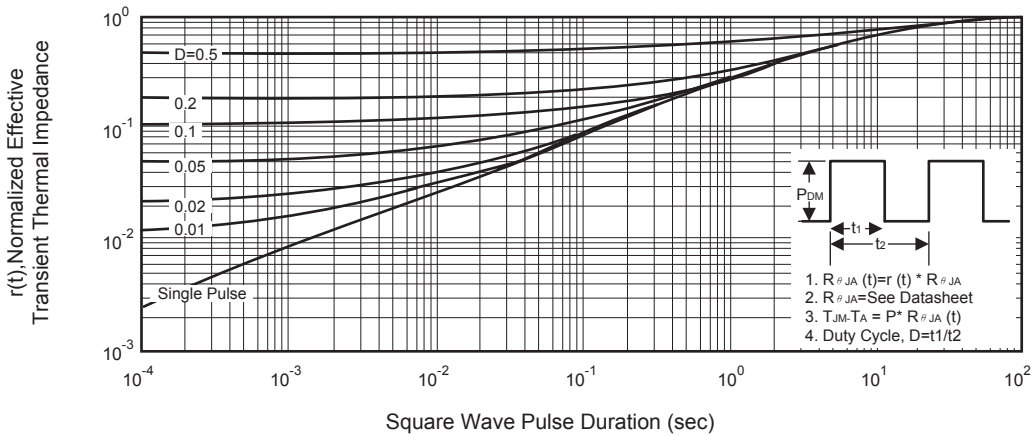

Figure 11. Normalized Thermal Transient Impedance Curve